

ROHS 客户图

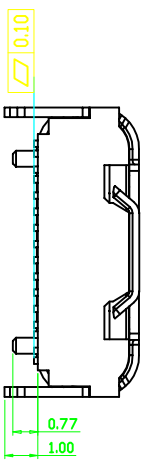
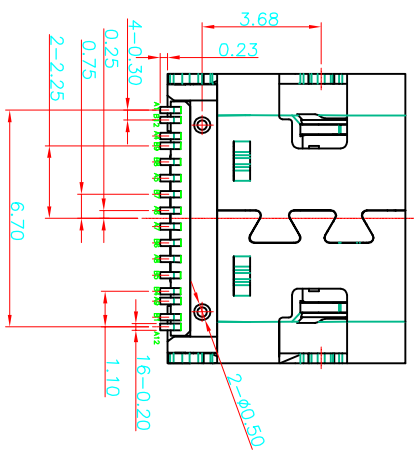
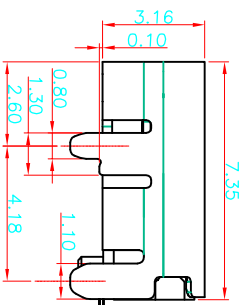
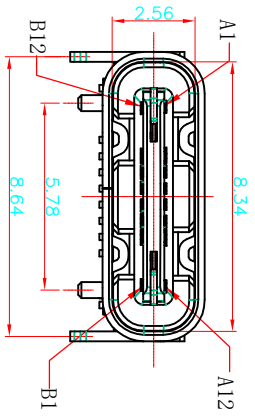
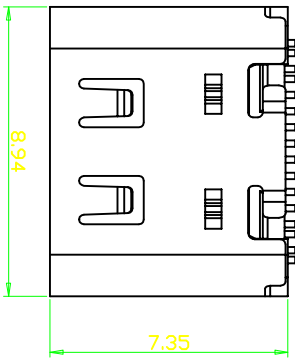

- NOTES:
SPECIFICATION:
1. CURRENT RATING: 5.0A MAX
 2. VOLTAGE: 100 VAC
 3. TEMPERATURE RANGE: -30 °C ~ 85 °C
 4. CONTACT RESISTANCE: 40 MILLIONHM MAX
 5. INSULATION RESISTANCE: 100 MEGOHMS MIN.
 6. INSERTION FORCE : 5N~20N
 7. UNMATING FORCE: 8N~20N
 8. DURABILITY: 10,000 CYCLES

深圳市鑫风雷电子有限公司

产品图 PRODUCT CHART DWG		单位 UNITS				MM	制图 DRAWING	王冠	产品料号 PRODUCT PART NO.	XFLC002-UCAF003-X
公差一览表 TOLERANCE UNLESS OTHERWISE		X	±0.30	X'	±5°	比例 SCALE	审核 CHECK	雷永健	产品名称 PRODUCT NO.	TYPE C母座单排16P有弹片
X	±0.25	X'	±2°							
XX	±0.30	XX'	±1°							
XXX	±0.15	XXX'	±0.5°	日期 DATE	2009/10/20	核准 APPD	雷永健	角法 VIEW	版本 VER	A0

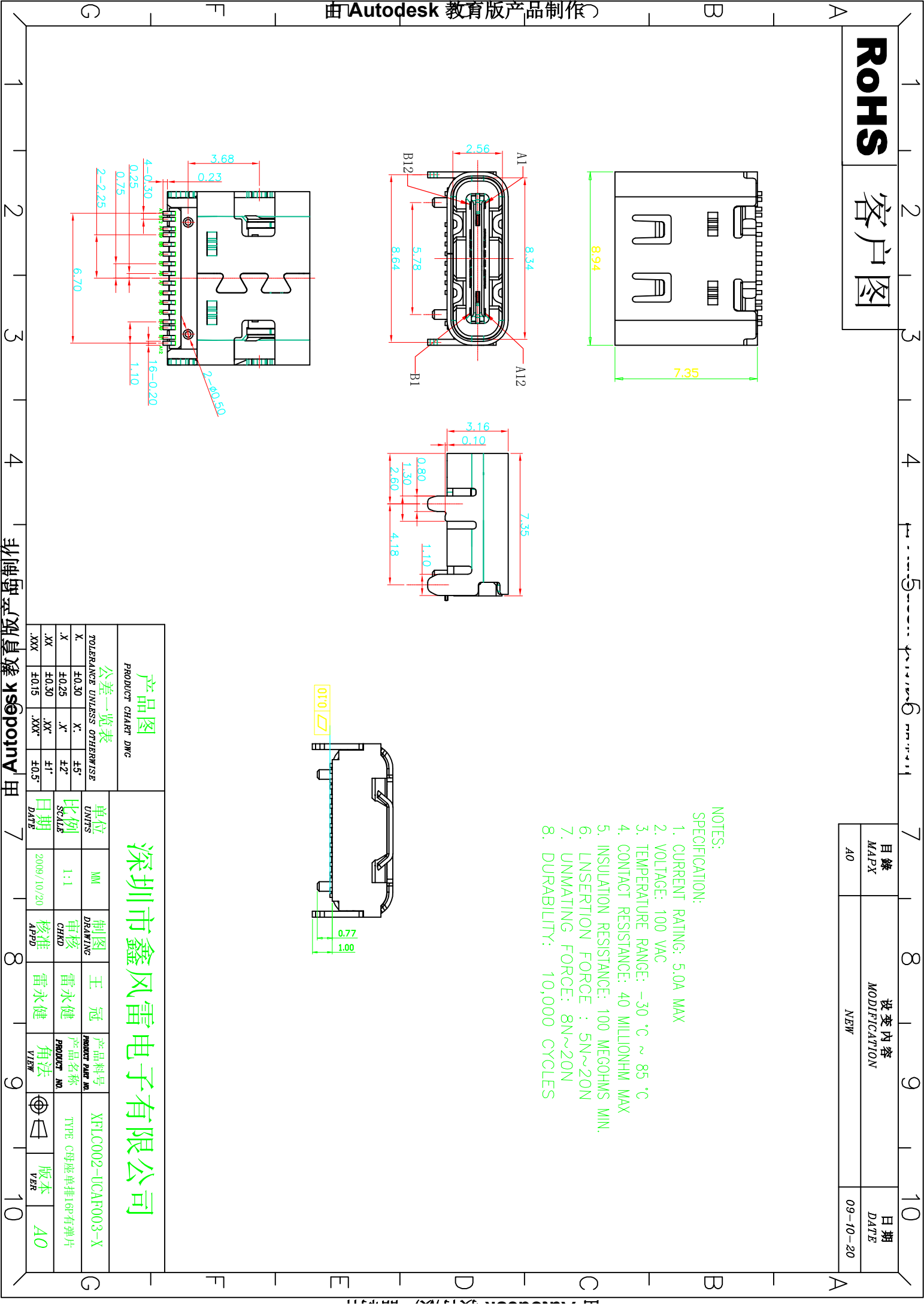

1 2 3 4 5 6 7 8 9 10

ROHS

客户图

目錄 MAPX	變更內容 MODIFICATION	日期 DATE
A0	NEW	09-10-20

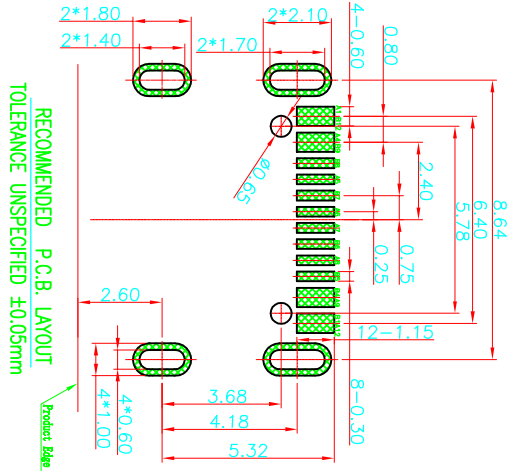

A1	GND	B12	GND
A4	VBUS	B9	VBUS
A5	CC1	B8	SBU2
A6	DP1	B7	DN2
A7	DN1	B6	DP2
A8	SBU1	B5	CC2
A9	VBUS	B4	VBUS
A12	GND	B1	GND
PIN	SIGNAL NAME	PIN	SIGNAL NAME

产品图
PRODUCT CHART DWG

深圳市鑫风雷电子有限公司

公差一览表 TOLERANCE UNLESS OTHERWISE		单位 UNITS	制图 DRAWING	产品料号 PRODUCT PART NO.
X	±0.30	X'	±5°	XFLC002-UCAP003-X
X	±0.25	X'	±2°	TYPE C母座单排16P有弹片
XX	±0.30	XX'	±1°	
.XXX	±0.15	.XXX'	±0.5°	

日期 DATE	审核 CHKD	核准 APPD	角法 VIEW	版本 VER
2009/10/20	雷永健	雷永健	☉	A0

RoHS 客户图

目錄 MAPX	變更內容 MODIFICATION	日期 DATE
A0	NEW	09-10-20

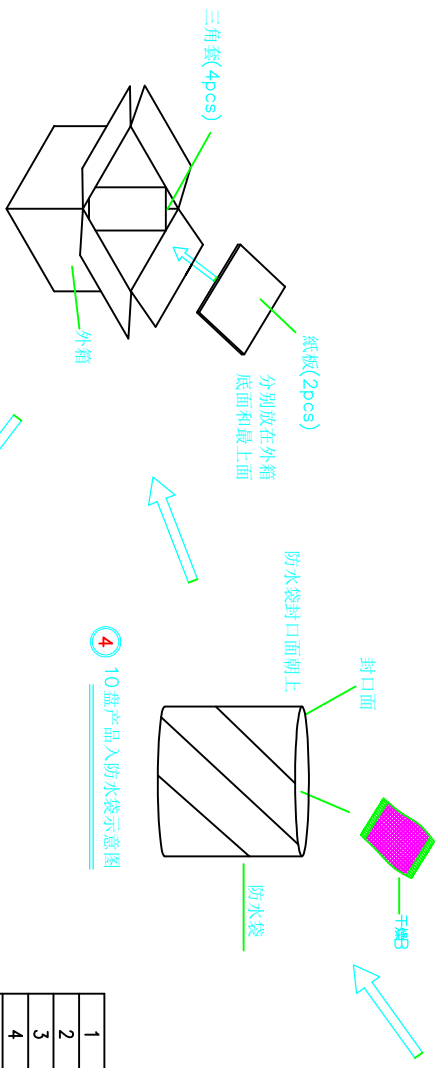
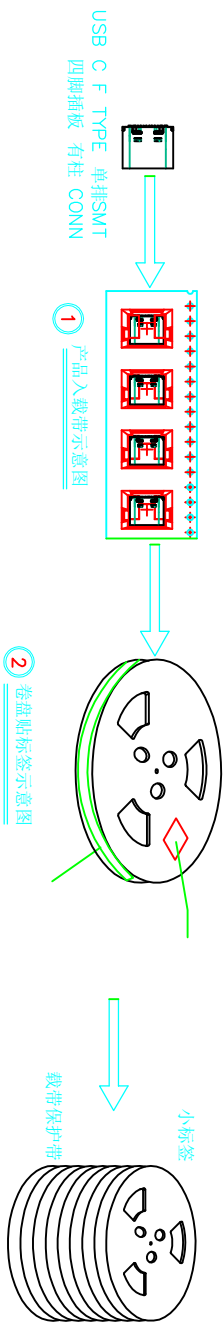

NOTE:

1. QUANTITY/REEL: 800 PCS
数量/卷: 800 PCS

QUANTITY/INNER CARTON: 800 X 10 = 8000 PCS
数量/箱: 800 X 10 = 8000 PCS

2. FREE 20 CAVE IN THE FRONT CARRIER ADN FREE 20 CAVE IN THE END CARRIER.
包装带内圈空15格 外圈空15格.

ITEM	DESC.	MATERIAL	REMARKS	QTY
1	成品			800
2	CARRIER TAPE PET		C TYPE 母座成品	
3	COVER TAPE PET		W=24mm T=0.35mm	
4	小?~		W=13.3mm T=0.05mm	
5	卷		L102mm*W59mm	10
6	天地板		φ330MM*W28.5MM	10
7	外?~		L380mm*W380mm	2
8	三角柱		L102mm*W102mm	1
9	外箱		L300mm*W210mm	4
10	防水袋		L400mm*W400mm*3.5mm	1
11	干棉包		L900mm*W800mm	1

产品图 深圳市鑫风雷电子有限公司

公差一览表		单位		制图		产品料号	
TOLERANCE	UNLESS OTHERWISE	MM	DRAWING	王冠	XPFLC002-UCAP003-X	TYPE C母座单排16P有弹片	
X	±0.30	X'	±5'	审核	雷永健	版本	
X	±0.25	X''	±2'	核准	雷永健	A0	
XX	±0.30	XX'	±1'	日期	2009/10/20	角法	
XXX	±0.15	XXX'	±0.5'	DATE		VER	