

ROHS

客户图

目錄 MAPX	變更內容 MODIFICATION	日期 DATE
A0	NEW	09-10-20

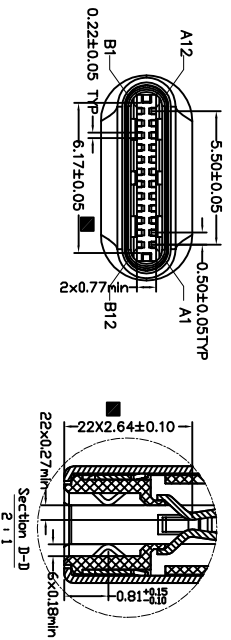
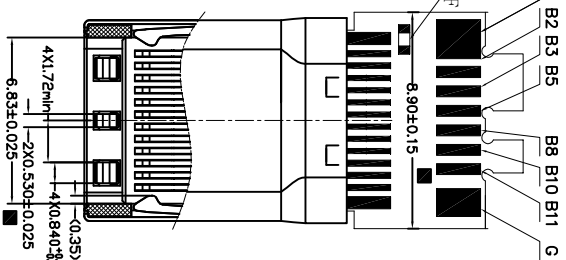
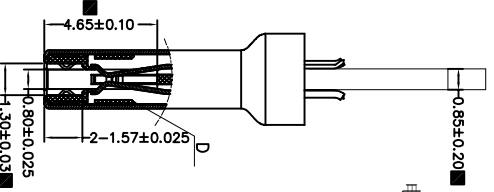
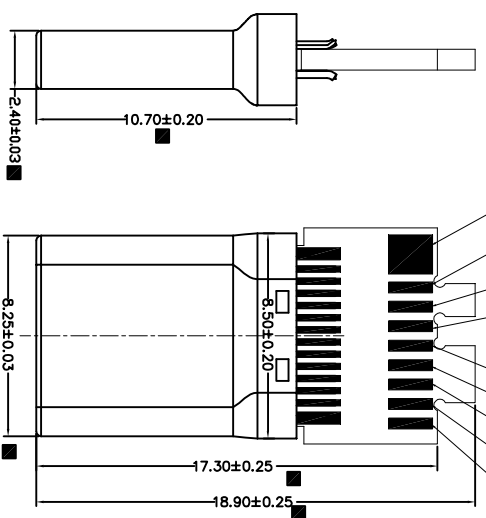
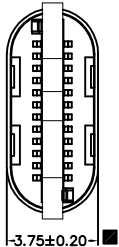

Pin Number	host	device	Pin Number	host	device
Pin A1	GND	GND	Pin B12	GND	GND
Pin A2	SSTxp1	SSTxp1	Pin B11	SSRxp1	SSRxp1
Pin A3	SSTxn1	SSTxn1	Pin B10	SSRxn1	SSRxn1
Pin A4	VBUS	VBUS	Pin B9	VBUS	VBUS
Pin A5	CC1	CC1	Pin B8	SBU2	SBU2
Pin A6	DP1	DP1	Pin B7		
Pin A7	DN1	DN1	Pin B6		
Pin A8	SBU1	SBU1	Pin B5	CC2	CC2
Pin A9	VBUS	VBUS	Pin B4	VBUS	VBUS
Pin A10	SSRxn2	SSRxn2	Pin B3	SSTxn2	SSTxn2
Pin A11	SSRxp2	SSRxp2	Pin B2	SSTxp2	SSTxp2
Pin A12	GND	GND	Pin B1	GND	GND

- 备注:
1. 材料: See Table A
 2. 电接要求: See Table A
 3. 机械特性:
插入力: 5-20N
拔出力: 8-20N
耐久次数: 10,000次
 4. 电气特性:
接触阻抗: 40mOhms Max(Initial)
50mOhms Max(after)
绝缘阻抗: 100Mohms Min
耐压: AC 100V/1分钟
额定电流:
5A for VBUS(For A4/A9,B4/B9)
1.25A for Vccm and GND(for A1/A12,B1/B5/B12)
0.25A for all other contacts.
 5. 使用物料及制程符合RoHS&HF.

6	LATCH	STAINLESS	: Ni: 50u"
5	CONTACT	COPPER ALLOY	Contact area: 5u", Solder tails: Tin80u", Ni: 30~80u"
4	molding 2	L.C.P	(Black)
3	GNDSPRING	STAINLESS	
2	Molding	L.C.P	(Black)
1	SHELL	STAINLESS	Ni: 50u"

公差一览表	
公差	公差
±0.30	±0.25
±0.20	±0.15
±0.15	±0.10

深圳市鑫风雷电子有限公司

单位	MM	制图	王冠	产品料号	XFLY012-UCAM023-X
比例	1:1	审核	雷永健	产品名称	TYPE C公头拉伸C-数据板焊盘加锡带封装
日期	2009/10/20	核准	雷永健	角法	
				版本	A0

1 2 3 4 5 6 7 8 9 10

RoHS

客户图

目錄 MAPX A0	變更內容 MODIFICATION NEW	日期 DATE 09-10-20
------------------	-----------------------------	------------------------

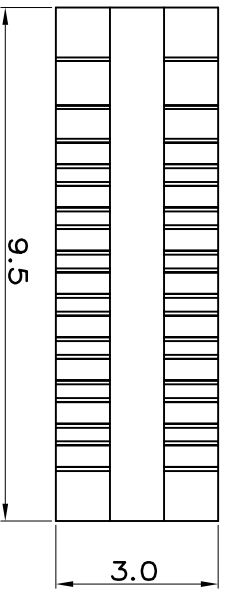
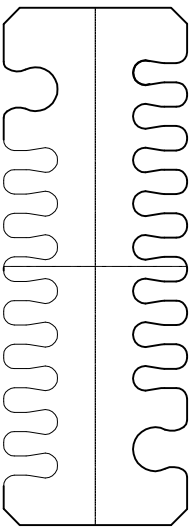
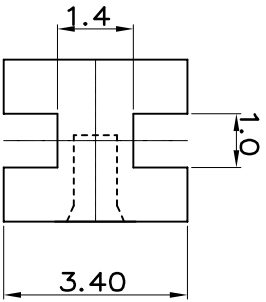
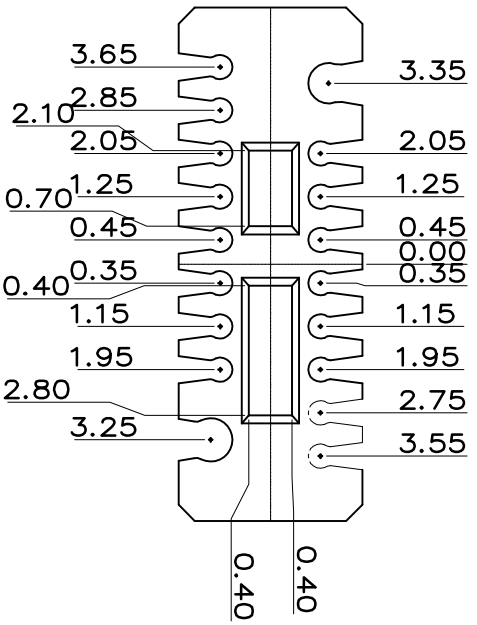

- 备注 (NOTE):
- 1. 材質: 見注釋
 - 2. 尺寸標註事項:
 - 2-1. 圖示有標註 "■" 記號者為重點管控尺寸;
 - 2-2. 圖示所有標註尺寸為首樣全檢尺寸;
 - 2-3. 圖示未標註公差之尺寸參考公差表;
 - 3. 品質要求事項:
 - 3-1. 不能有縮水, 起泡, 燙傷, 彎曲變形;
 - 3-2. 不能有刮傷, 划伤, 壓痕, 拉料及不飽模狀態出現;
 - 3-3. 毛邊要求: 0.03 MAX. 所有毛邊不能影響功能和超過外觀標準;
 - 3-4. 扭曲變型度: 0.05mm MAX;
 - 3-5. 需要做實配動作 ■

1	線夾 DESC.	SEE NOTES MATERIAL	PAGE REMARKS	PART REMARKS
---	-------------	-----------------------	-----------------	--------------

產品圖
PRODUCT CHART DWG

深圳市鑫風雷電子有限公司

公差一覽表 TOLERANCE UNLESS OTHERWISE SPECIFIED		單位 UNITS	MM	制圖 DRAWING	王冠	產品料號 PRODUCT PART NO.	XFLY012-UCAM023-X
X	±0.30	X'	±5'	審核 CHKD	雷永健	產品名稱 PRODUCT NO.	TYPE C公頭 C-C 線夾
XX	±0.25	XX'	±2'	核准 APPD	雷永健	角法 VIEW	☉ ☐
XXX	±0.20	XXX'	±1'	日期 DATE	2009/10/20	版本 VER	A0
	±0.15		±0.5'				