

ROHS 客户图

| | | |
|------------------|-----------------------------|------------------------|
| 目錄 MAPX A0 | 變更內容 MODIFICATION NEW | 日期 DATE 09-10-20 |
|------------------|-----------------------------|------------------------|

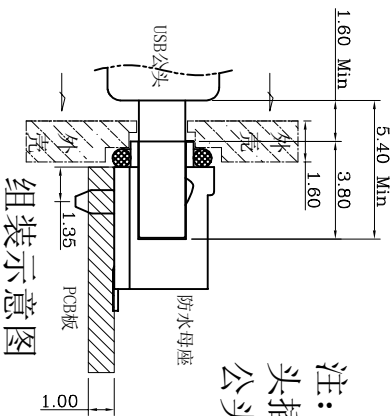
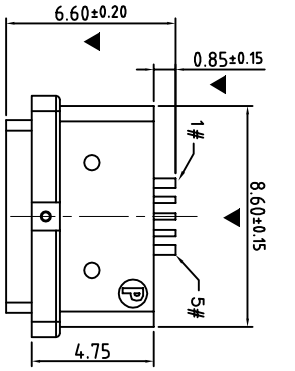

注：设计时，请注意公头插入时的距离，防止公头插不到底。

- SPECIFICATIONS:
- ELECTRICAL CHARACTERISTICS:
 - RATING: 3A(PIN1&5)/0.5A(PIN2&3&4);
 - CONTACT RESISTANCE: 30 mΩ MAX.(INITIAL);
 - DIELECTRIC WITHSTANDING: 500V AC MIN.;
 - INSULATION RESISTANCE: 1000MΩ MIN.;
 - DURABILITY: 5,000 CYCLES MIN.;
 - INSERTION FORCE: 3.5Kgf (35N) Max.;
 - EXTRACTION FORCE: 0.8Kgf (8N) Min.;
 - WATER PROOFNESS: THIS PRODUCT IS BASED ON IPX6.
 - PLUG INTERFACE DIMENSIONS CONFORM TO USB2.0 SPEC.
 - PACKAGING: TAPE & REEL.

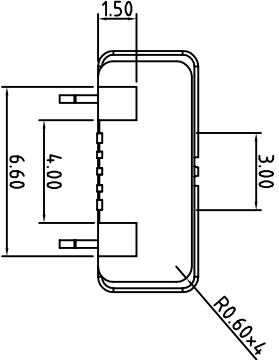
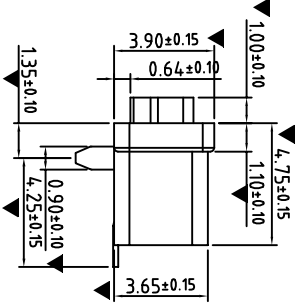
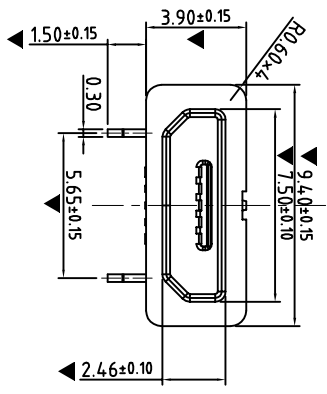

P.C.B LAYOUT

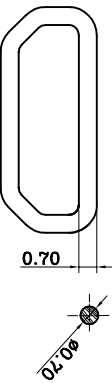
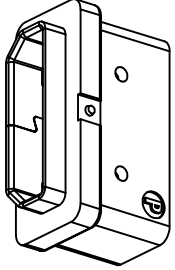
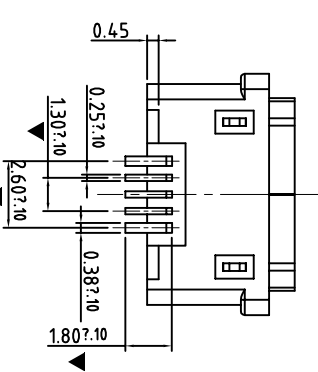
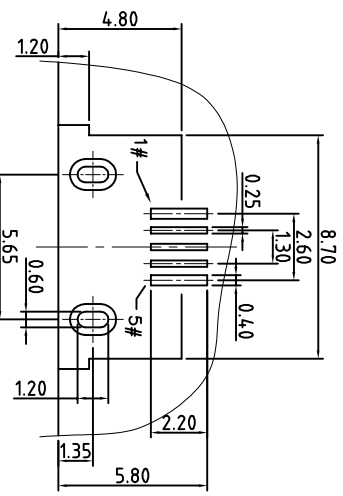

注：防水圈是圆形截面，直径为0.7mm的硅胶圈
防水圈挤压量，由0.7mm挤压到0.3mm ~ 0.4mm, 防水效果好

| | | | | | |
|---|---------|---|---|--------|------|
| 3 | Shell | 1 | SUS304R-1/2H Ni Plating±0.30mm | | |
| 2 | Contact | 5 | Phosphor bronze C5191R-EH Au/Ni Plating T=0.20mm | | |
| 1 | Housing | 1 | PA9T&ICP (GF30%) | FINISH | NOTE |

产品图

公差一览表
TOLERANCE UNLESS OTHERWISE SPECIFIED

| | | | |
|------|-------|-------|-------|
| X | ±0.30 | X' | ±5' |
| .X | ±0.25 | .X' | ±2' |
| .XX | ±0.30 | .XX' | ±1' |
| .XXX | ±0.15 | .XXX' | ±0.5' |

深圳市鑫风雷电子有限公司
Shenzhen xinfenglei Electronic Co., Ltd

| | | | | | |
|-------------|------------|---------------|-----|--------------------------|--------------------------|
| 单位 UNITS | MM | 制图 DRAWING | 王冠 | 产品料号 PRODUCT PART NO. | 00208-UMKF001-A |
| 比例 SCALE | 1:1 | 审核 CHKD | 雷永健 | 产品名称 PRODUCT NO. | MICRO 5P母座脚距5.6防水 外露1.0短 |
| 日期 DATE | 2009/10/20 | 核准 APPD | 雷永健 | 角法 VIEW | |
| | | | | 版本 VER | A0 |

| Contact Number | Signal Name | Remarks |
|----------------|-------------|------------------|
| 1# | VBUS | Power |
| 2# | D- | Date- |
| 3# | D+ | Date+ |
| 4# | ID | Reserve or Gound |
| 5# | GND | Gound |