

# ROHS 客户图

目錄 MAPX A0	變更內容 MODIFICATION NEW	日期 DATE 09-10-20
------------------	-----------------------------	------------------------

注：设计时，请注意公头插入时的距离，防止公头插不到底。

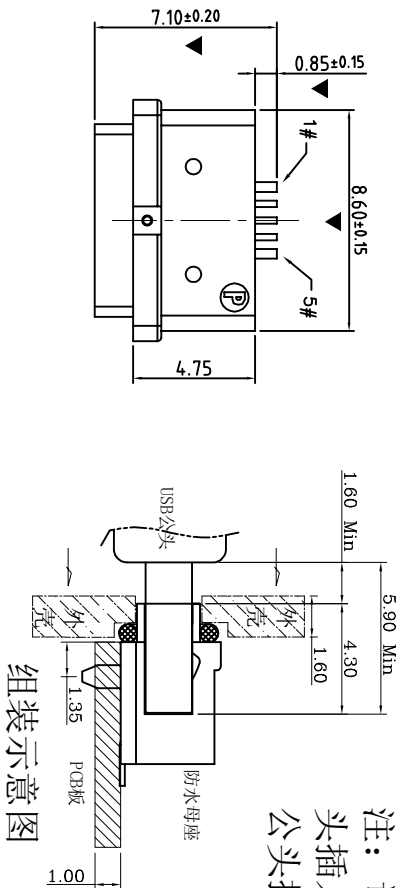

组装示意图

- SPECIFICATIONS:
- ELECTRICAL CHARACTERISTICS:
    - RATING: 3A(PIN1&5),0.5A(PIN2&3&4);
    - CONTACT RESISTANCE: 30 mΩ MAX.(INITIAL);
    - DIELECTRIC WITHSTANDING: 500V AC MIN.;
    - INSULATION RESISTANCE: 1000MΩ MIN.;
  - DURABILITY: 5,000 CYCLES MIN.;
  - INSERTION FORCE: 3.5kgf (35N) Max.;
  - EXTRACTION FORCE: 0.8kgf (8N) Min.;
  - WATER PROOFNESS: THIS PRODUCT IS BASED ON IPX6.
  - PLUG INTERFACE DIMENSIONS CONFORM TO USB2.0 SPEC.
  - PACKAGING: TAPE & REEL.

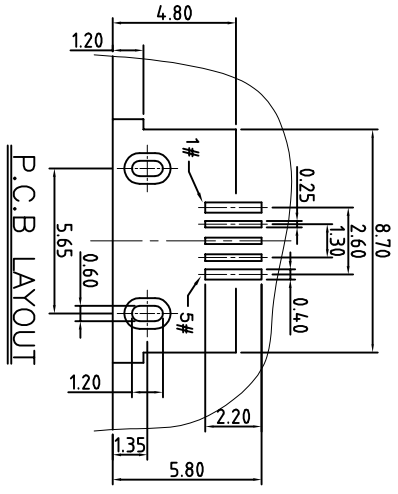
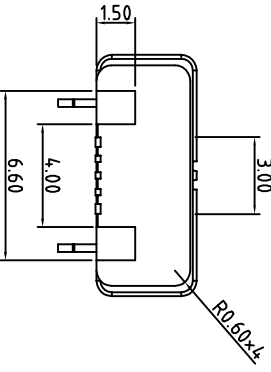
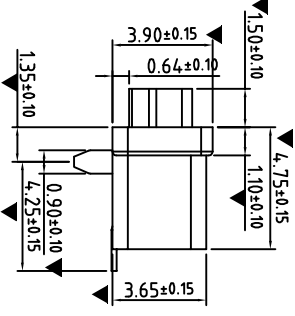
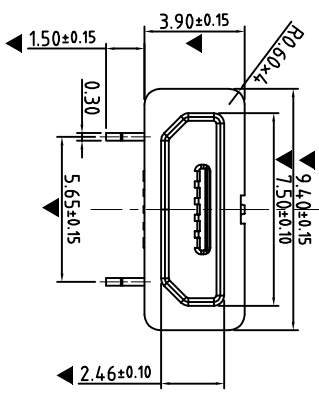

P.C.B LAYOUT

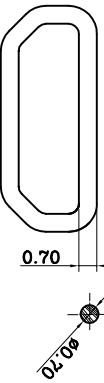
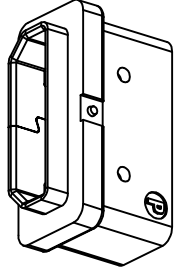
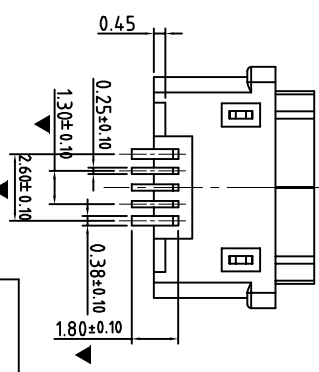

注：防水圈是圆形截面，直径为0.7mm的硅胶圈  
防水圈挤压力量，由0.7mm挤压到0.3mm ~ 0.4mm, 防水效果好

3	Shell	1	SUS304R-1/2H Ni Plating $\Gamma=0.30\text{mm}$		
2	Contact	5	Phosphor bronze C5191R-EH Au/Ni Plating $T=0.20\text{mm}$		
1	Housing	1	PA9T&LCP (G.F30%)		
ITEM	PART NAME	Q'TY	FINISH		NOTE

## 产品图

深圳市鑫风雷电子有限公司  
Shenzhen xinfenglei Electronic Co., Ltd

公差一览表		单位		比例		日期		制图		产品料号	
TOLERANCE UNLESS OTHERWISE		UNITS		SCALE		DATE		DRAWING		PRODUCT PART NO.	
X	±0.30	X	±5'	X	1:1	2009/10/20	王冠	00208-UMKF001-B			
.X	±0.25	.X	±2'				雷永健				
.XX	±0.30	.XX	±1'				雷永健				
.XXX	±0.15	.XXX	±0.5'								

Contact Number	Signal Name	Remarks
1#	VBUS	Power
2#	D-	Date-
3#	D+	Date+
4#	ID	Reserve or Ground
5#	GND	Ground