

RoHS

客户图

目録 MAPX A0	変更内容 MODIFICATION NEW	日期 DATE 09-10-20
------------------	-----------------------------	------------------------

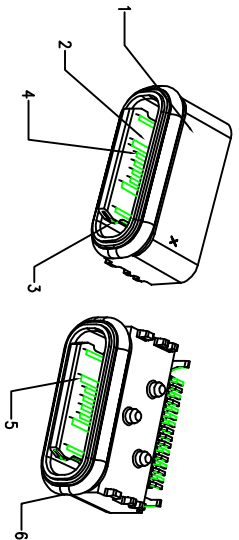
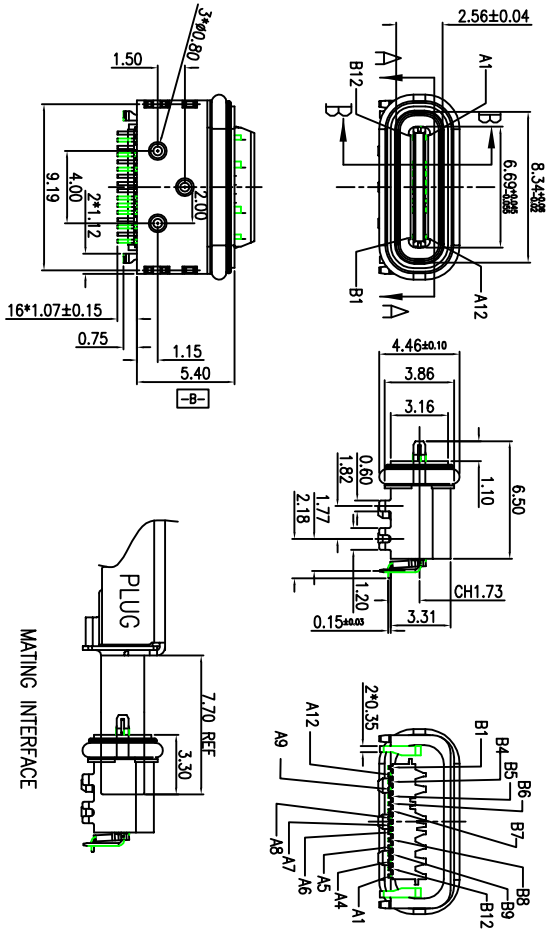
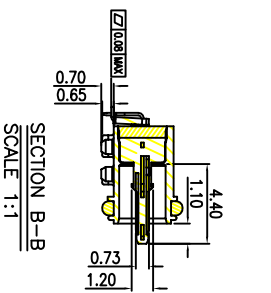
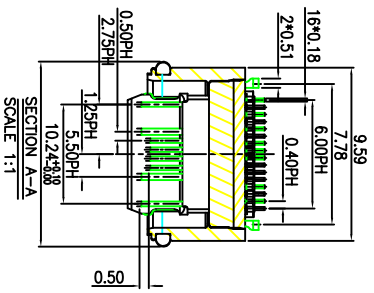

- NOTES:
- ELECTRICAL:
 - CONTACT CURRENT RATING 5.0A FOR VBUS AND GND(PINS A4 A9 B4 B9)
 - INSULATION RESISTANCE: 100 MEGAOHMS MIN. AT 250VDC.
 - DIELECTRIC WITHSTANDING VOLTAGE: 100VAC MIN.
 - LOW CONTACT RESISTANCE: INITIAL 40mΩ MAX. AFTER 50mΩ MAX.
 - MECHANICAL CHARACTERISTICS:
 - INSERTION FORCE: 5N~20N FORM 1 TO 1000CYCLES.
 - EXTRACTION FORCE: 8N~20N FORM 1 TO 10000CYCLES.
 - DURABILITY: 10,000 MATING CYCLES.
 - OPERATING TEMPERATURE: -55°C TO +85°C
 - COPLANARITY: 0.08MAX.
 - PART NUMBER INFORMATION:

PART NUMBER	CONTACT PLATING
	GOLD FLASH
	AU 5U"
	AU 10U"
	AU 15U"
	AU 30U"

TABLE

TEMP	PART NAME	QTY	MATERIAL	REMARK
1	SHELL	1PCS	STAINLESS	NICKEL PLATED 50U" MIN. OVER ALL
2	INSERT	1PCS	PA10T	U194V-0
3	MID-PLATE	1PCS	STAINLESS	NI PLATED 50U" MIN. OVER ALL
4	CONTACT TOP	1SET	COPPER ALLOY	SEE NOTES
5	CONTACT BOTTOM	1SET	COPPER ALLOY	SEE NOTES
6	RUBBER RING	1PCS	SILICA GEL	BLACK

产品图
PRODUCT CHART DWG

公差一览表
TOLERANCE UNLESS OTHERWISE

公差	单位	比例
.XX	MM	1:1
.XX	MM	±2°
.XXX	MM	±1°
.XXX	MM	±0.5°

日期 DATE: 2009/10/20

制图 DRAWTING: 王冠

审核 CHECK: 雷永健

核准 APPRO: 雷永健

产品料号 PRODUCT PART NO: 00206-UCAR006-X

产品名称 PRODUCT NO: TYPE C 16P板上型母座防水=6.45

角法 VIEW: 版本 VER: A0

深圳市鑫风雷电子有限公司

RoHS 客户图

目錄 MAPX A0	變更內容 MODIFICATION NEW	日期 DATE 09-10-20
------------------	-----------------------------	------------------------

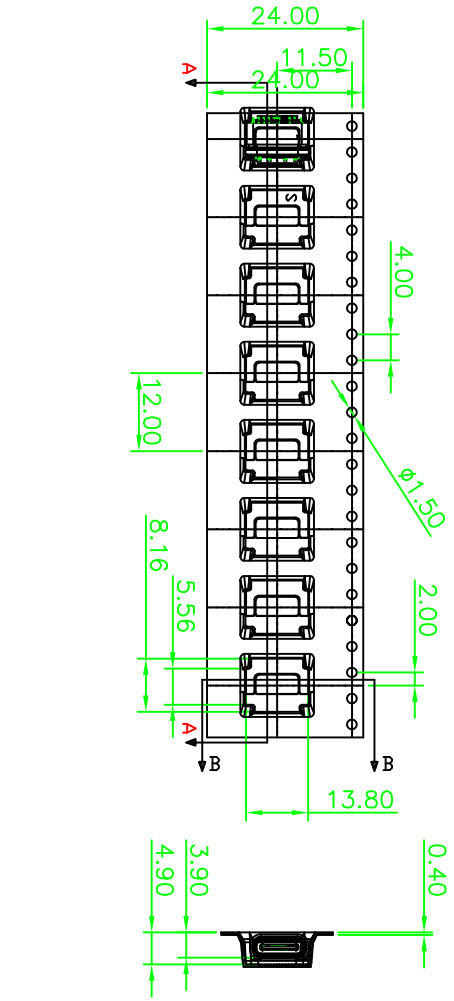
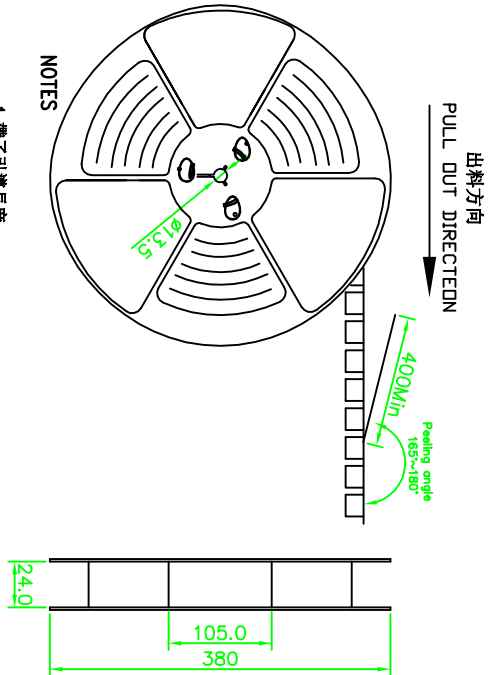

NOTES

- 1.帶子引導長度
LEAD TAPE LENGTH
出料方向
PULL OUT DIRECTEON
- 2.上帶 剝力為: 0.1~1.3N(10.2gf~130gf)
PEELING OFF FORCE OF TOP TAPE:0.1~1.3N(10.2gf~130gf)
出貨運輸過程中一定注意:
THIS REQUIREMENT SHOULD BE APPLIED AT SHIPMENT:
卷帶在運輸過程中不能散開
PEELING OFF SHOULD NOT BE ALLOWED DURING TRANSPORTATION

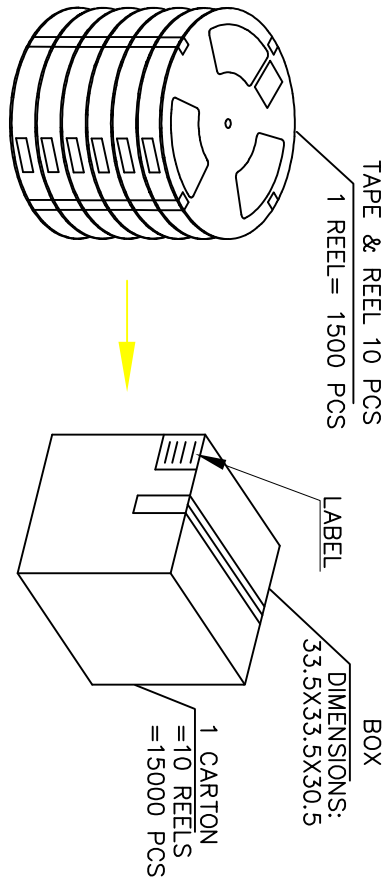
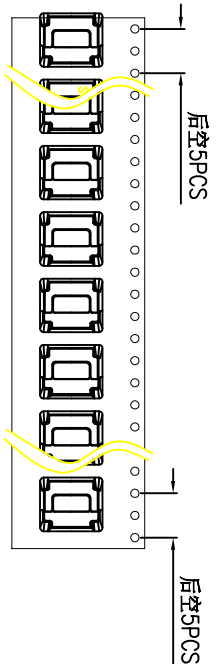

产品图

深圳市鑫风雷电子有限公司

公差一览表 TOLERANCE UNLESS OTHERWISE		单位 UNITS	MM	制图 DRAWING	王冠	产品料号 PRODUCT PART NO.	00206-UCAR006-X
X	±0.30	X'	±5'	审核 CHECK	雷永健	产品名称 PRODUCT NO.	TYPE C 16P板上型母座防水=6.45
.XX	±0.25	.X'	±2'	核准 APPD	雷永健	角法 VIEW	
.XX	±0.30	.XX'	±1'	日期 DATE	2009/10/20	版本 VER	A0
.XXX	±0.15	.XXX'	±0.5'				