

# ROHS 客户图

目錄 MAPX	变更内容 MODIFICATION	日期 DATE
A0	NEW	09-10-20

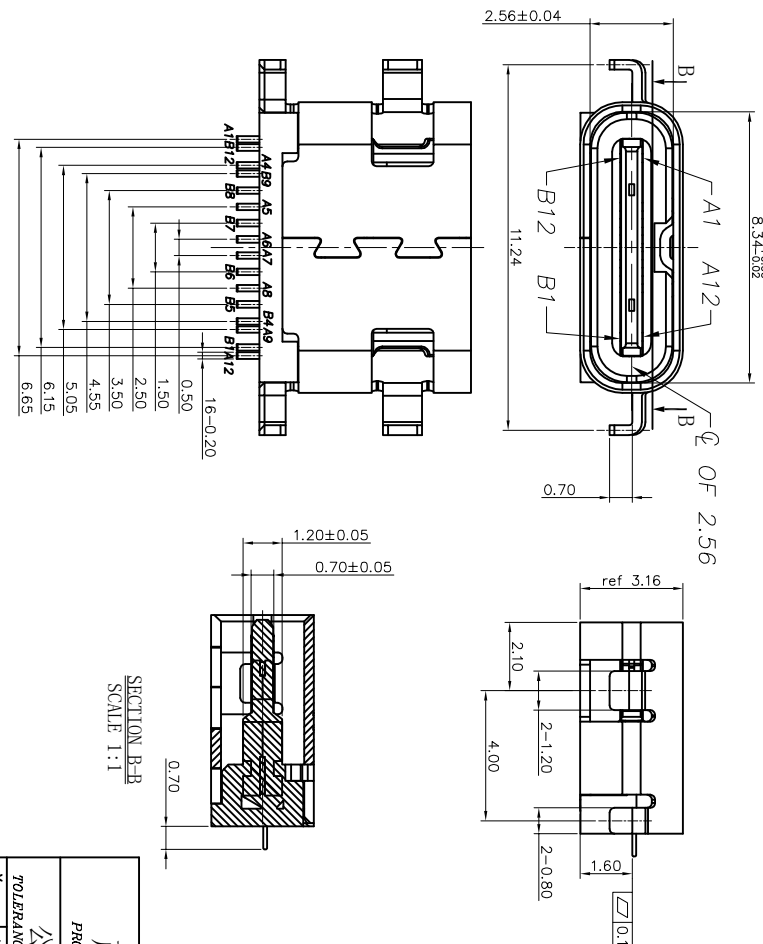
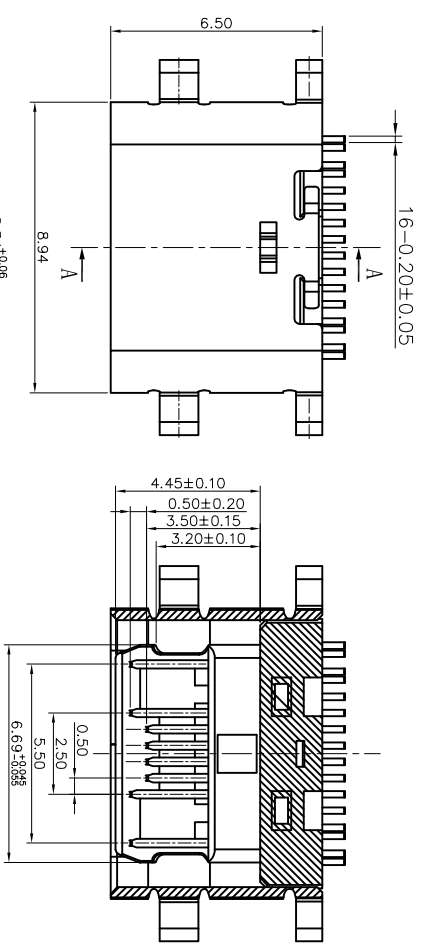

- NOTE:
1. MATERIAL SPECIFICATION:
    1. HOUSING: HIGH TEMPERATURE RESISTANT PLASTIC, UL94 V-0.
    2. CONTACTS: COPPER ALLOY
    3. MID PLATE: STAINLESS STEEL
  2. PLATING SPECIFICATION:
    - 2-1. CONTACTS:
      - NI 50u" MIN. UNDER PLATED OVER ALL.
      - AU PLATED ON THE FUNCTIONAL AREA OF CONTACT.
    - 2-2. FRONT SHELL:
      - NI 30u" MIN. UNDER PLATED OVER ALL.
  3. MECHANICAL PERFORMANCE:
    - 3-1. INSERTION FORCE: 0.5~2.0kgf.
    - 3-2. REMOVAL FORCE: 0.8kgf~2.0kgf.
    - 3-3. DURABILITY: 10000 CYCLES.
  4. ELECTRICAL PERFORMANCE:
    - 4-1. CURRENT RATING: 5A
    - 4-2. INSULATION RESISTANCE: 100MΩ MIN
    - 4-3. DIELECTRIC WITHSTAND VOLTAGE: AC 100V FOR 1 MINUTE.
  5. ENVIRONMENTAL PERFORMANCE:
    - 5.1. OPERATING TEMPERATURE: -30°C~+80°C.
    - 5.2. I.R. REFLOW:
      - THE PEAK TEMPERATURE ON THE BOARD SHALL BE MAINTAINED FOR 10 SECONDS AT 260°C.

## 产品图

## 深圳市鑫风雷电子有限公司

公差一览表  
TOLERANCE UNLESS OTHERWISE

X	±0.30	X'	±5'	单位 UNITS	MM	制图 DRAWING	王冠	产品料号 PRODUCT PART NO.	00206-UCAR005-X
XX	±0.25	X''	±2'	比例 SCALE	1:1	审核 CHKD	雷永健	产品名称 PRODUCT NO.	TYPE C 16P母座沉板1.6
.XXX	±0.15	.XXX'	±1.5'	日期 DATE	2009/10/20	核准 APPD	雷永健	角法 VIEW	⊕
								版本 VER	A0

# RoHS

# 客户图

目錄 MAPX	变更内容 MODIFICATION	日期 DATE
A0	NEW	09-10-20

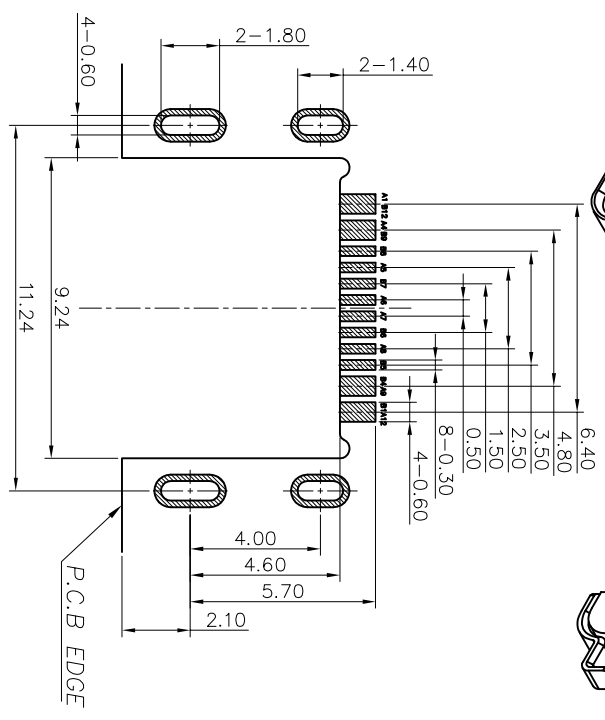
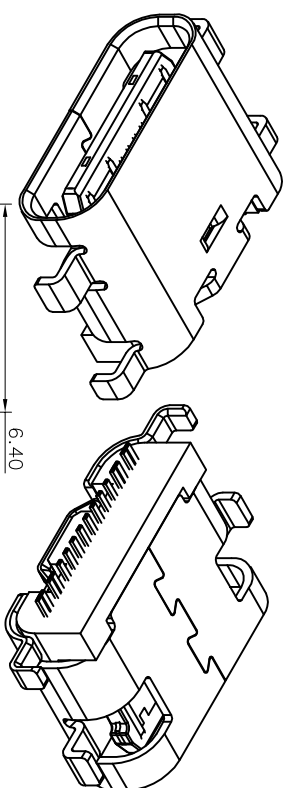

RECOMMEND P.C.B LAYOUT(COMPONENT SIDE)  
TOLERANCE FOR PCB LAYOUT IS ± 0.05

### USB TYPE-C PIN ASSIGNMENTS

PIN NUMBER	SIGNAL NAME	PIN NUMBER	SIGNAL NAME
A1	GND	B12	GND
A4	VBUS	B9	VBUS
A5	CC1	B8	SBU2
A6	Dp1	B7	Dn2
A7	Dn1	B6	Dp2
A8	SBU1	B5	CC2
A9	VBUS	B4	VBUS
A12	GND	B1	GND

### 产品图

## 深圳市鑫风雷电子有限公司

公差一览表 TOLERANCE UNLESS OTHERWISE SPECIFIED		单位 UNITS	MM	制图 DRAWING	王冠	产品料号 PRODUCT PART NO.	00206-UCAR005-X
X	±0.30	X'	±5°	审核 CHKD	雷永健	产品名称 PRODUCT NO.	TYPE C 16P母座沉板1.6
.XX	±0.25	.X'	±2°	批准 APPD	雷永健	角法 VIEW	TYPE C 16P母座沉板1.6
.XXX	±0.15	.XXX'	±1.5°	日期 DATE	2009/10/20	版本 VER	A0

# RoHS 客户图

目錄 MAPX A0	變更內容 MODIFICATION NEW	日期 DATE 09-10-20
------------------	-----------------------------	------------------------

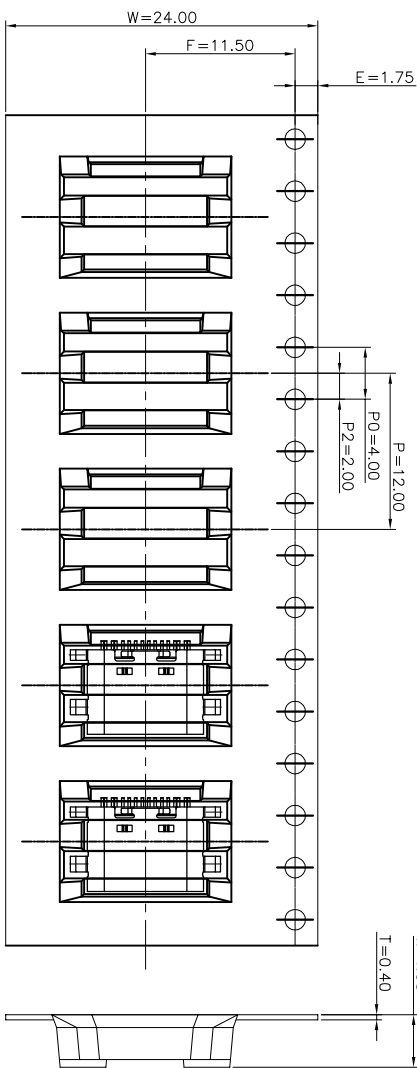
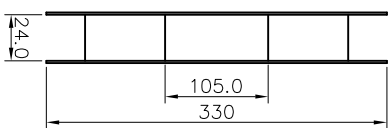
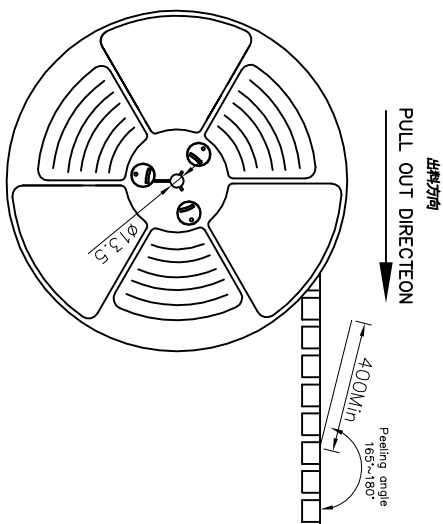

## NOTES

1. 帶子引導長度  
LEAD TAPE LENGTH

出料方向  
PULL OUT DIRECTION

出料方向  
PULL OUT DIRECTION

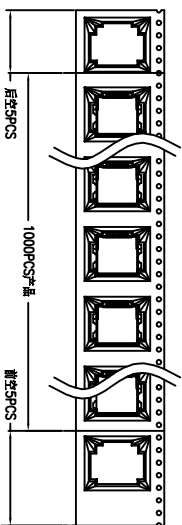

2. 上帶 剝力力為: 0.1~1.3N(10.2gf~130gf)  
PEELING OFF FORCE OF TOP TAPE: 0.1~1.3N(10.2gf~130gf)

出貨、運輸過程中一定注意:

THIS REQUIREMENT SHOULD BE APPLIED AT SHIPMENT:

卷帶在運輸過程中不能散開

PEELING OFF SHOULD NOT BE ALLOWED DURING TRANSPORTATION

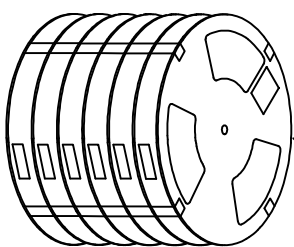

TAPE & REEL 10 PCS  
= 1200 PCS

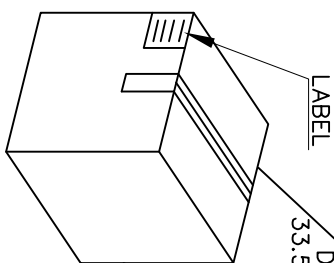

BOX  
DIMENSIONS:  
33.5X33.5X30.5

1 CARTON  
= 10 REELS  
= 12000 PCS

(The detail of the packaging)

包裝規格	(Packaging Capacity)		重量	
產品料號 (Product No.)	包裝數量 pcs/box	boxes/Carton	Pcs/Box	N.W./Pcs N.W./Box G.W./Box
00206-UCAR005-X	1200	10	12000	-----

## 產品圖

PRODUCT CHART DWG

## 深圳市鑫风雷电子有限公司

公差一览表 TOLERANCE UNLESS OTHERWISE		單位 UNITS	MM	制圖 DRAWING	王冠	產品料號 PRODUCT PART NO.	00206-UCAR005-X
X	±0.30	X	±5°	審核 CHKD	雷永健	產品名稱 PRODUCT NO.	TYPE C 16P母座沉板1.6
.XX	±0.25	.X	±2°	核准 APPD	雷永健	角法 VIEW	TYPE C 16P母座沉板1.6
.XXX	±0.15	.XXX	±1°	日期 DATE		版本 VER	A0