

RoHS 客户图

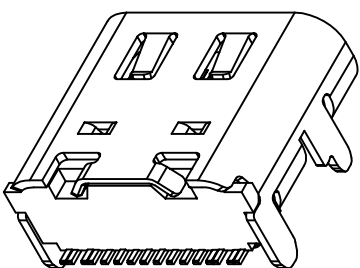

- NOTES:
SPECIFICATION:
1. CURRENT RATING: 5.0A MAX
 2. VOLTAGE: 100 VAC
 3. TEMPERATURE RANGE: -30 °C ~ 85 °C
 4. CONTACT RESISTANCE: 40 MILLIONHM MAX
 5. INSULATION RESISTANCE: 100 MEGOHMS MIN.
 6. INSERTION FORCE : 5N~20N
 7. UNMATING FORCE: 8N~20N
 8. DURABILITY: 10,000 CYCLES

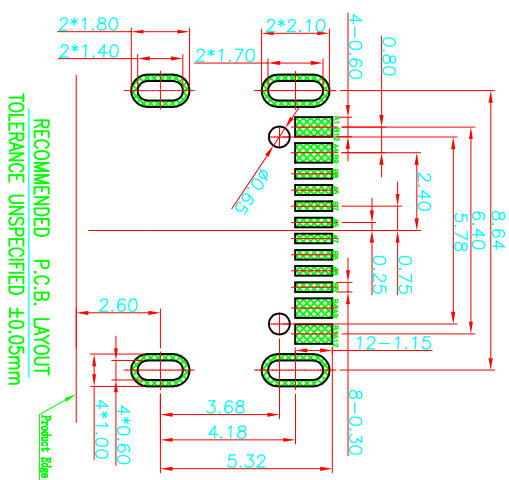
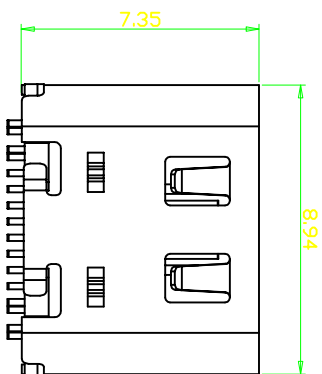
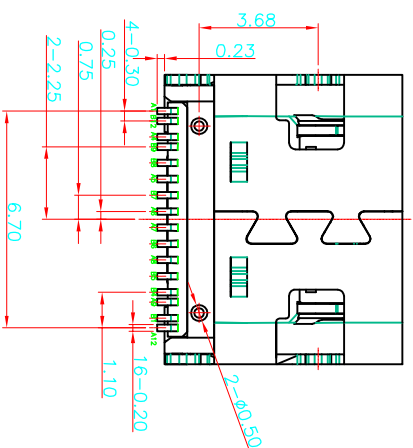
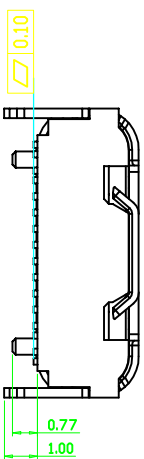
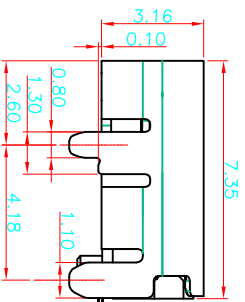
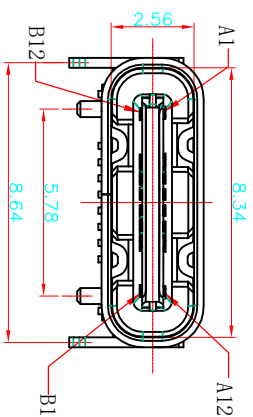

A1	GND	B12	GND
A4	VBUS	B9	VBUS
A5	CC1	B8	SBU2
A6	DP1	B7	DN2
A7	DN1	B6	DP2
A8	SBU1	B5	CC2
A9	VBUS	B4	VBUS
A12	GND	B1	GND
PIN	SIGNAL NAME	PIN	SIGNAL NAME

深圳市鑫风雷电子有限公司

公差一览表		单位		制图		产品料号	
TOLERANCE UNLESS OTHERWISE		UNITS		DRAWING		PRODUCT PART NO.	
X	±0.30	X	±5°	王冠	00302-UCAR003-X		
X	±0.25	X	±2°	雷永健	产品名称	TYPE C母座单排16P有弹片	
XX	±0.30	XX	±1°	雷永健	角法	版本	
XXX	±0.15	XXX	±0.5°		日期	A0	
					DATE	2009/10/20	

目錄	修改內容	日期
MAPX	MODIFICATION	DATE
A0	NEW	09-10-20

目錄 MAPX	變更內容 MODIFICATION	日期 DATE
A0	NEW	09-10-20

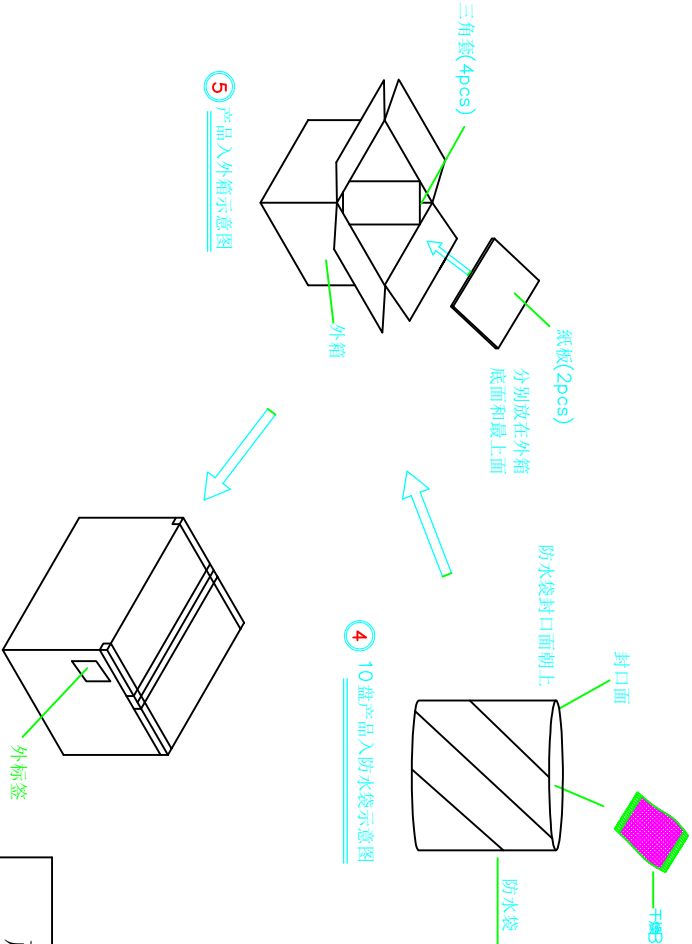
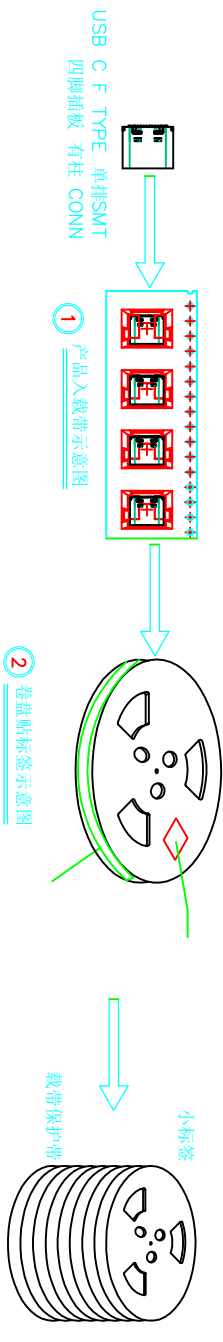

NOTE:
 1. QUANTITY/REEL: 800 PCS
 数量/卷: 800 PCS
 QUANTITY/INNER CARTON: 800 X 10 = 8000 PCS
 数量/箱: 800 X 10 = 8000 PCS
 2. FREE 20 CAVE IN THE FRONT CARRIER ADN FREE
 20 CAVE IN THE END CARRIER.
 包装带内圈空15格, 外圈空15格.

1	成品	C-TYPE 硬盘成品	800
2	CARRIER TAPE PET	W=24mm T=0.35mm	
3	COVER TAPE PET	W=13.5mm T=0.05mm	
4	小?~	L102mm*W59mm	10
5	卷	φ330MM*W28.5MM	10
6	天地板	L380mm*W380mm	2
7	外?~	L102mm*W102mm	1
8	三角柱	L300mm*W210mm	4
9	外箱	L400mm*W400mm*33.5mm	1
10	防水袋	L900mm*W800mm	1
11	干燥		1

产品图 深圳市鑫风雷电子有限公司

公差一览表 TOLERANCE UNLESS OTHERWISE SPECIFIED		单位 UNITS	MM	制图 DRAWING	王冠	产品料号 PRODUCT PART NO.	00302-UCAF003-X
X	±0.30	X'	±5'	审核 CHKD	雷永健	产品名称 PRODUCT NO.	TYPE C母座单排16P有弹片
.XX	±0.25	.X'	±2'	批准 APPD	雷永健	角法 VIEW	
.XXX	±0.15	.XXX'	±0.5'	日期 DATE	2009/10/20	版本 VER	A0