

RoHS 客户图

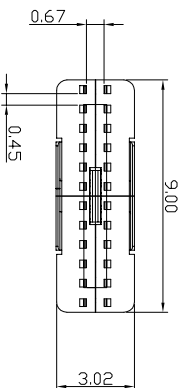
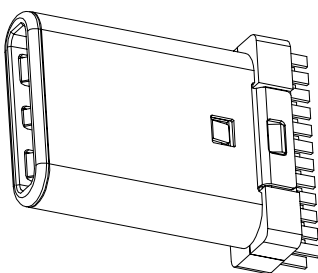
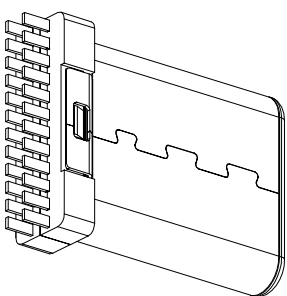
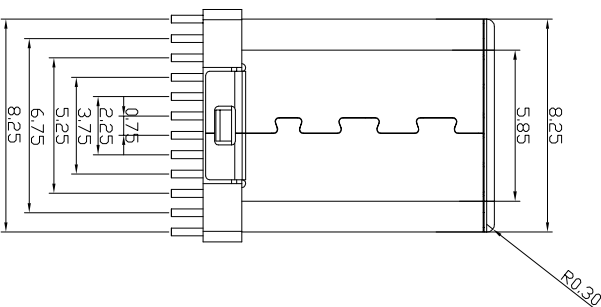
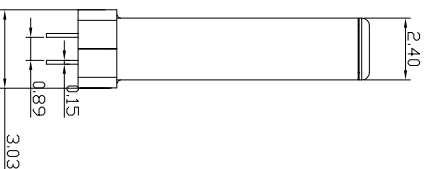
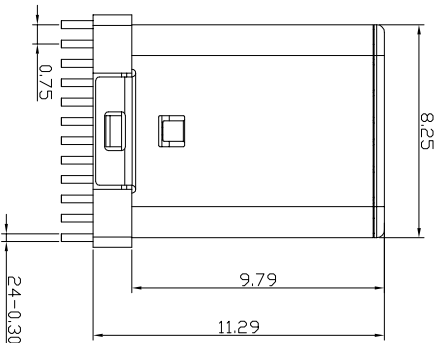
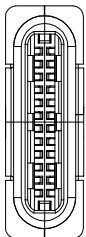

| | | |
|------------------|-----------------------------|------------------------|
| 目錄 MAPX A0 | 變更內容 MODIFICATION NEW | 日期 DATE 09-10-20 |
|------------------|-----------------------------|------------------------|

| | | | | | |
|----|---|------|----|---|------|
| 1 | A | GND | 12 | B | GND |
| 2 | | | 11 | | |
| 3 | | | 10 | | |
| 4 | | VBUS | 9 | | PWR |
| 5 | | CC | 8 | | SBU2 |
| 6 | | D- | 7 | | D+ |
| 7 | | D+ | 6 | | D- |
| 8 | | SBU1 | 5 | | Vcon |
| 9 | | VBUS | 4 | | PWR |
| 10 | | | 3 | | |
| 11 | | | 2 | | |
| 12 | | GND | 1 | | GND |

注：1、电性参数
接触电阻：40mΩ Max
绝缘电阻：100MΩ Min
耐压：100V AC
2、机械参数
插入力：5N~20N
拔出力：5N~20N
耐久性：10000 Cycles
500 cycles per hour

产品图

深圳市鑫风雷电电子有限公司

| | | | | | | | |
|---|-------|-------------|-------|---------------|------------|--------------------------|-----------------------|
| 公差一览表 TOLERANCE UNLESS OTHERWISE SPECIFIED | | 单位 UNITS | MM | 制图 DRAWING | 王冠 | 产品料号 PRODUCT PART NO. | 18002-UCAM001-X |
| X | ±0.30 | X' | ±5' | 审核 CHKD | 雷永健 | 产品名称 PRODUCT NO. | TYPE C 24P公头插板式L=11.3 |
| .X | ±0.25 | .X' | ±2' | 核准 APPD | 雷永健 | 角法 VIEW | 版本 VER |
| .XX | ±0.30 | .XX' | ±1' | 日期 DATE | 2009/10/20 | | A0 |
| .XXX | ±0.15 | .XXX' | ±0.5' | | | | |