

1

2

3

4

5

6

7

8

9

10

# RoHS 客户图

目錄 MAPX	变更内容 MODIFICATION	日期 DATE
A0	NEW	09-10-20

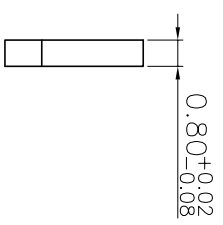
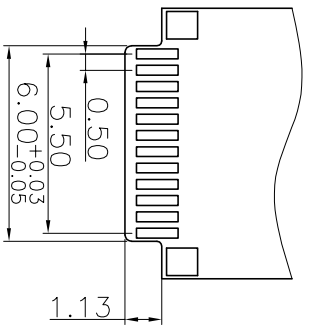
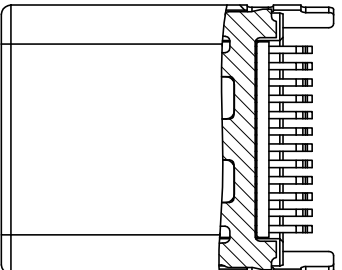
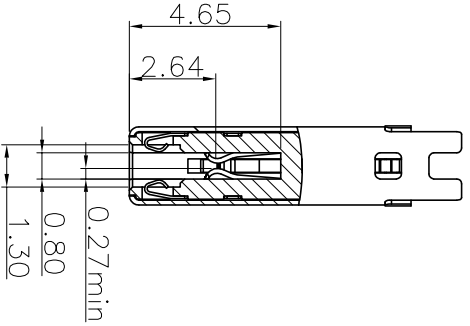
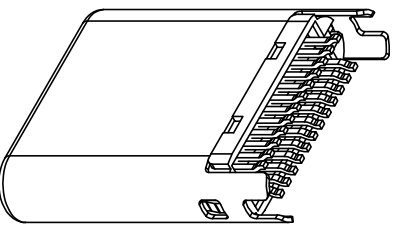
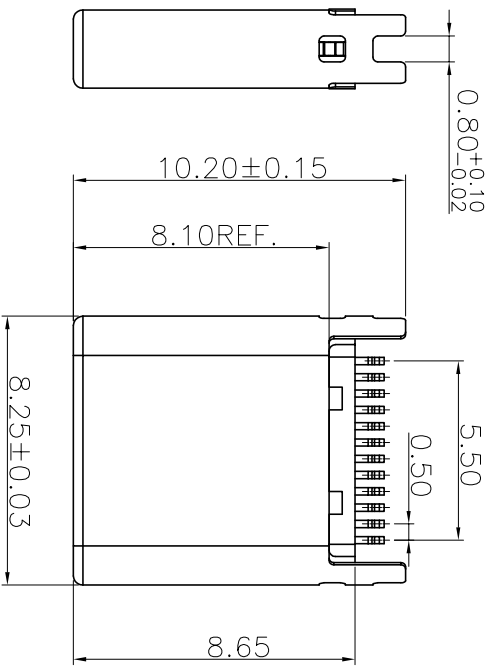
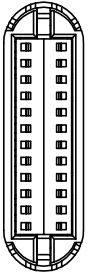

RECOMMENDED P.C.B. LAYOUT  
TOLERANCE UNSPECIFIED ±0.05mm

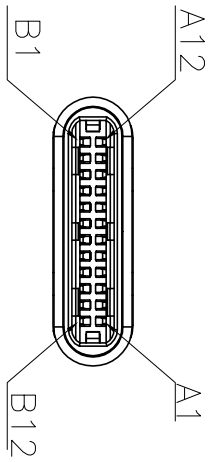

## 产品图

PRODUCT CHART DWG

### 公差一览表

TOLERANCE UNLESS OTHERWISE	公差一览表	单位 UNITS	比例 SCALE	日期 DATE	制图 DRAWING	审核 CHKD	核准 APPD	产品料号 PRODUCT PART NO.	产品名称 PRODUCT NO.	联系方式 CONTACT
X	±0.30	X	±5'		王冠 Wangguan	雷永健 Leiyongjian	雷永健 Leiyongjian	00702-UCAM005-X	Type C 24p 公头夹板 0.8 L=8.65	mailbox: sale1@xfll.com.com
X	±0.25	X	±2'		雷永健 Leiyongjian	雷永健 Leiyongjian	雷永健 Leiyongjian			www.xfll.com.com
.XX	±0.20	.XX	±1'							
.XXX	±0.15	.XXX	±0.5'	2009/10/20						

深圳市鑫风雷电子有限公司  
Shenzhen xinfenglei Electronics Co., Ltd