

RoHS 客户图

| | | |
|------------------|-----------------------------|------------------------|
| 目錄 MAPX A0 | 變更內容 MODIFICATION NEW | 日期 DATE 09-10-20 |
|------------------|-----------------------------|------------------------|

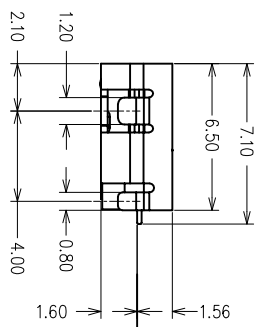

0.10Max

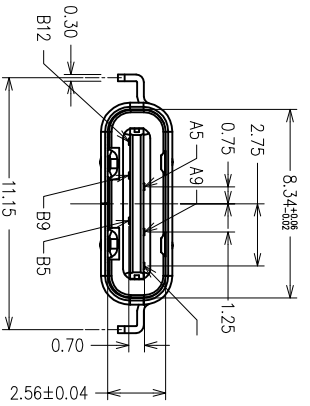
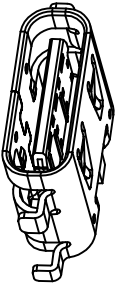
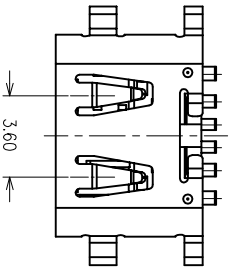
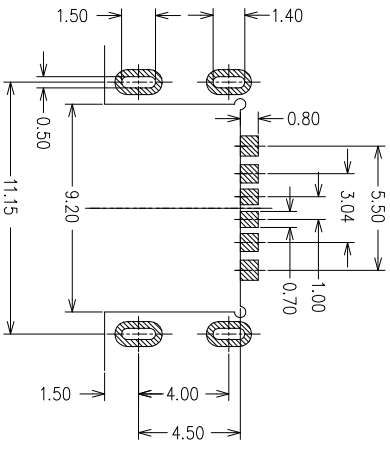
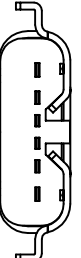

RECOMMENDED PCB LAYOUT
TOLERANCE UNSPECIFIED ±0.05mm

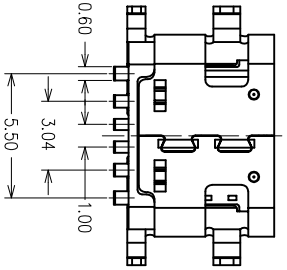

- SPECIFICATION**
1. ELECTRICAL CHARACTERISTICS:
 1-1. VOLTAGE/CURRENT RATINGS: DC 30V MAXࣘA
 1-2. CONTACT RESISTANCE: 40mΩ MAX INITIAL
 1-3. INSULATION RESISTANCE:
 1000MΩ MIN FOR VOLTAGE 100VDC
 1-4. DIELECTRIC WITHSTAND: 100V AC for 1 MINUTE
 1-5. OPERATING TEMPERATURE: -25°C~+85°C
2. MECHANICAL CHARACTERISTICS:
 2-1. INSERT FORCE: 5~20N Max
 2-2. WITHDRAW FORCE: 5~20N Min
 2-3. LIFE TEST :5,000 CYCLES

| | | | |
|-----|-------------|-----|-------------|
| A5 | CC1 | B12 | GND |
| A9 | VBUS | B9 | VBUS |
| A12 | GND | B5 | CC2 |
| PIN | SIGNAL NAME | PIN | SIGNAL NAME |

深圳市鑫风雷电子有限公司

| NO. | DESCRIPTION | MATERIAL | REMARKS | QTY |
|-----|-------------|--------------------------|--------------|-----|
| 4 | SHELL | STAINLESS STEEL | | PCS |
| 3 | MO | COPPER ALLOY | BLACK | PCS |
| 2 | CONTACT | COPPER ALLOY | Au/Ni Plated | PCS |
| 1 | HOUSING | HIGH TEMPERATURE PLASTIC | BLACK | PCS |

| | | | | | | | | | | | | |
|--------------------------|-------|-------------------------------------|-------|-------------|-------------|------------|---------------|-------------|--------------|--------------------------|-----------------------------|------------|
| 产品图 PRODUCT CHART DWG | | 公差一览表 TOLERANCE UNLESS OTHERWISE | | 单位 UNITS | 比例 SCALE | 日期 DATE | 制图 DRAWING | 审核 CHECK | 核准 APPROV | 产品料号 PRODUCT PART NO. | 产品名称 PRODUCT NO. | 图法 VIEW |
| X | ±0.30 | X' | ±5' | MM | 1:1 | 2009/10/20 | 王冠 | 雷永健 | 雷永健 | 01002-UCAF005-X | TYPE 0 6P 每罐5000个 1.6 L=6.6 | 版本 VER |
| .XX | ±0.20 | .XX' | ±2' | | | | | | | | | A0 |
| .XXX | ±0.15 | .XXX' | ±0.5' | | | | | | | | | |