

RoHS 客户图

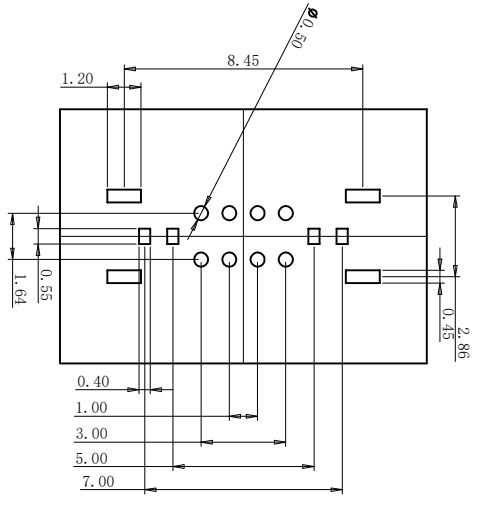

1. ELECTRICAL CHARACTERISTICS:
 - 1-1. CONTACT RESISTANCE: 30m Ω MAX.
 - 1-2. DIELECTRIC WITHSTANDING VOLTAGE: 100V AC FOR ONE MINUTE.
 - 1-3. INSULATION RESISTANCE: 100M Ω MIN. MEASURED BY 500 VDC.
2. MECHANICAL CHARACTERISTICS:
 - 2-1. INSERTION FORCE : 0.5-2.0Nf (BER.)
 - 2-2. WITHDRAWAL FORCE : 0.8-2.0Nf (BER.)
3. LIFE TEST: 10,000 CYCLES.

RECOMMENDED P.C.B. LAYOUT (1:1.00mm)
TOLERANCE UNSPECIFIED ±0.05mm

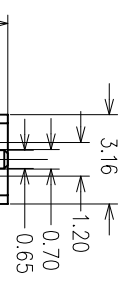
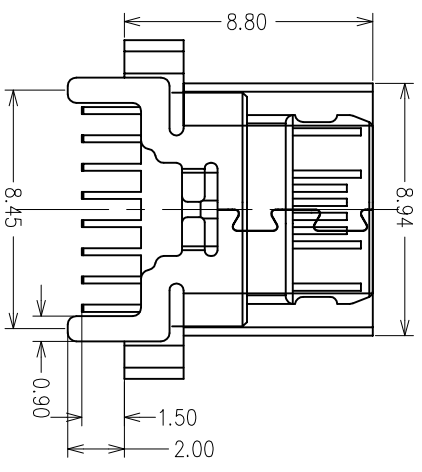
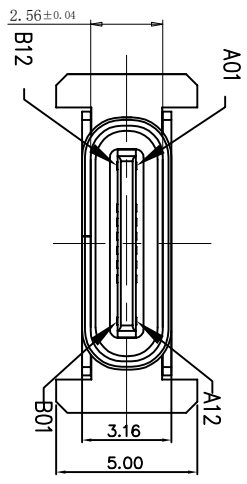
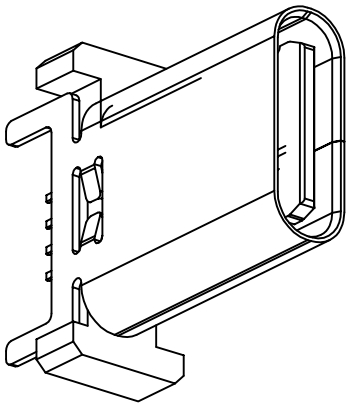
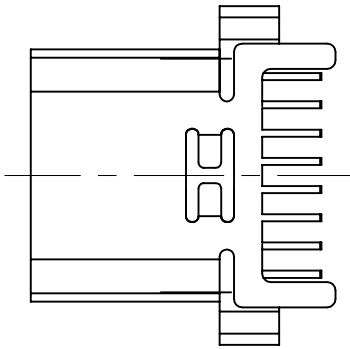
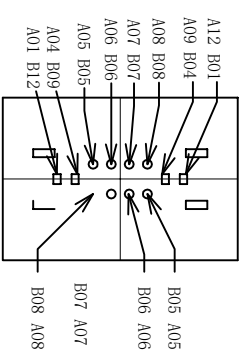

A1	010	010	010	010	010	010	010	010	010
A2	010	010	010	010	010	010	010	010	010
A3	010	010	010	010	010	010	010	010	010
A4	010	010	010	010	010	010	010	010	010
A5	010	010	010	010	010	010	010	010	010
A6	010	010	010	010	010	010	010	010	010
A7	010	010	010	010	010	010	010	010	010
A8	010	010	010	010	010	010	010	010	010
A9	010	010	010	010	010	010	010	010	010
A10	010	010	010	010	010	010	010	010	010
A11	010	010	010	010	010	010	010	010	010
A12	010	010	010	010	010	010	010	010	010
B11	010	010	010	010	010	010	010	010	010
B12	010	010	010	010	010	010	010	010	010

产品图 PRODUCT CHART DWG		单位 UNITS		制图 DRAWING		至 REV		产品料号 PRODUCT PART NO.		TYPE O 16P每座180度DIP H=8.8	
公差一览表 TOLERANCE UNLESS OTHERWISE		MM		审核 CHKD		雷永健		01002-UCAF023-X		版本 VER	
X	±0.30	X	±5°	比例 SCALE		雷永健		1:1		A0	
XX	±0.25	X	±2°	日期 DATE		雷永健		2009/10/20		A0	
XXX	±0.20	XX	±1°	核准 APPD							
XXX	±0.15	XXX	±0.5°	日期 DATE							

深圳市鑫风雷电子有限公司