

# RoHS 客户图

目錄 MAPX	变更内容 MODIFICATION	日期 DATE
A0	NEW	09-10-20

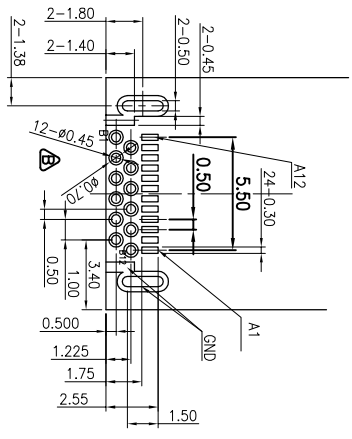
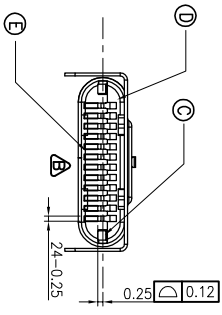
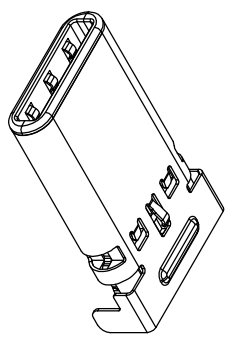
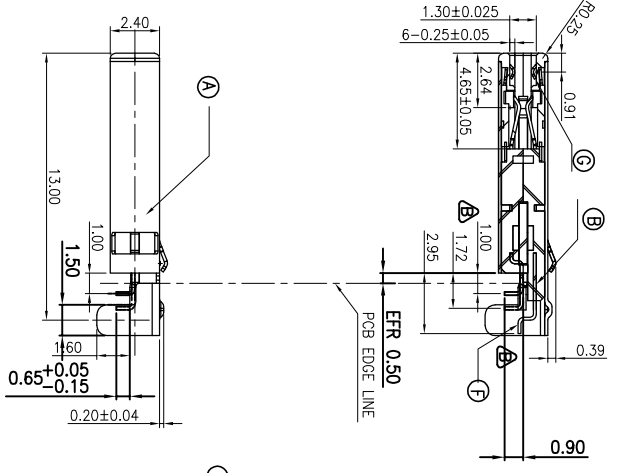
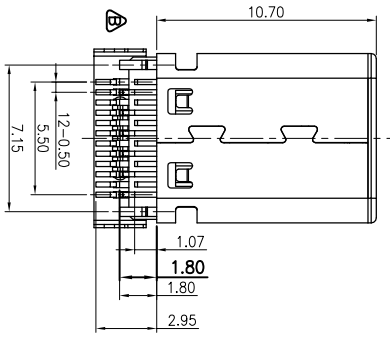
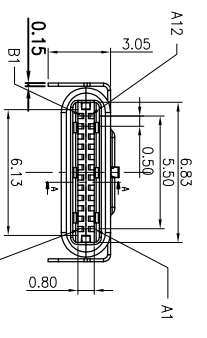
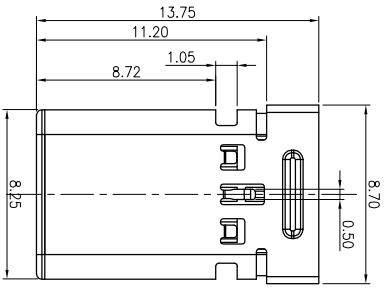

Recommended P.C.B Layout  
Tolerance ±0.05

- NOTES:  
SPECIFICATION:  
1. CURRENT RATING: 3.0A MAX  
2. Withstanding Voltage: 100V AC  
3. TEMPERATURE RANGE: -30 °C ~ 85 °C  
4. CONTACT RESISTANCE: 40 MILLIONHM MAX  
5. INSULATION RESISTANCE: 100 MEGOHMS  
6. INSERTION FORCE : 5N~20N  
7. UNMATING FORCE: 8N~20N (1~10000X后)  
8. DURABILITY: 6N~20N (10000X2后)  
10,000 CYCLES

Pin Number	host	device	Pin Number	host	device
PN A1 GND	GND	PN B12 GND	GND		
PN A2 SSTW1	SSTW1	PN B11 SSRW1	SSRW1		
PN A3 SSTW1	SSTW1	PN B10 SSRW1	SSRW1		
PN A4 VBUS	VBUS	PN B9 VBUS	VBUS		
PN A5 CCI	CCI	PN B8 SBU2	SBU2		
PN A6 Dp1	Dp1	PN B7 Dn2	Dn2		
PN A7 Dn1	Dn1	PN B6 Dp2	Dp2		
PN A8 SBU1	SBU1	PN B5 C22	C22		
PN A9 VBUS	VBUS	PN B4 VBUS	VBUS		
PN A10 SSRW2	SSRW2	PN B3 STW2	STW2		
PN A11 SSRW2	SSRW2	PN B2 STW2	STW2		
PN A12 GND	GND	PN B1 GND	GND		

ITEM	QTY	DESCRIPTION	UNIT	PACKAGE
G	2	SUS304 T=0.10		
F	12	CS210 T=0.10		
E	1	LPF-3.50MHz JIL 9AV-0		
D	1	LPF-3.50MHz JIL 9AV-0		
C	12	SUS307 T=0.20		
B	12	SUS310 T=0.15		
A	1	SUS310 T=0.20		
NO		DESCRIPTION		

## 产品图

## 深圳市鑫风雷电子有限公司

公差一览表		单位	MM	制图	王冠	产品料号	26010-UCAM005-X
TOLERANCE UNLESS OTHERWISE		UNITS		DRAWING		PRODUCT PART NO.	
X	±0.30	X	±5°	审核	雷永健	产品名称	TYPE C公头弹片式沉板前插后
X	±0.25	X	±2°	核准	雷永健	角法	带有凸包有弹片两侧有开口
XX	±0.30	XX	±1°	日期	2009/10/20	版本	A0
XXX	±0.15	XXX	±0.5°	DATE		VIEW	