

RoHS 客户图

目錄 MAPX A0	變更內容 MODIFICATION NEW	日期 DATE 09-10-20
------------------	-----------------------------	------------------------

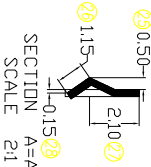
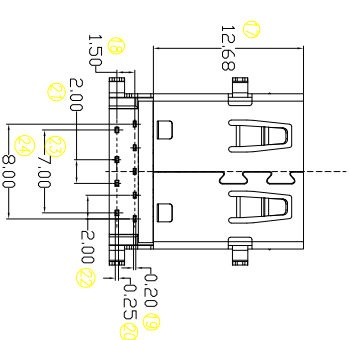
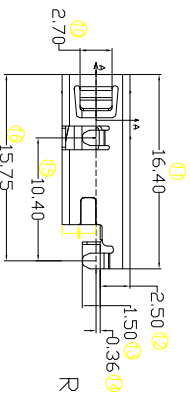
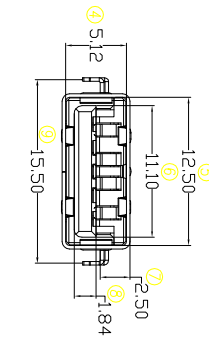
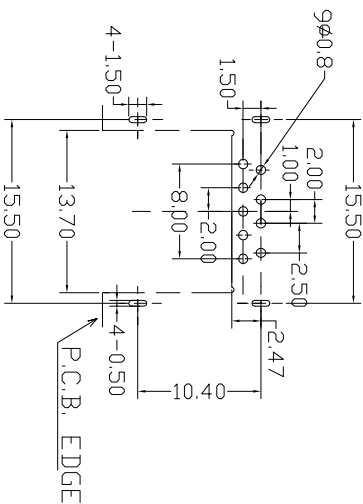
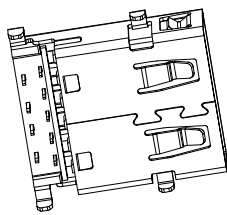
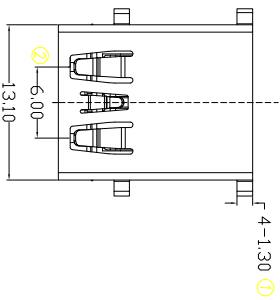

RECOMMENDED P,C,B, LAYOUT (TOP VIEWS)
TOLERANCE:±0.05

- Note:
- 1.Material:
- 1.1 Housing: LCP+30%GF, BLACK, UL 94V-0
 - 1.2 COVER: LCP+30%GF, BLACK, UL 94V-0
 - 1.3 Shell: SK7-HI,
 - 1.4 Contact: COPPER ALLDLY C2680/C519
- 2.FINISH:
- 2.1 CONTACT Plate with Gold G/F Plate
 - 2.2 shell: Nickel 80U<(MIN) Plate
- 3.Specification:
- 3.1 Dielectric withstanding voltage: 100V(AC).
 - 3.2 Contact resistance: 50mΩ Max
 - 3.3 Insulation resistance: 100MΩ Min

4	USB 3.0 A/F DIP外壳	C2680R-H	1
3	USB 3.0 A/F DIP下端子	C2680	5
2	USB 3.0 A/F DIP上端子	C5191	4
1	USB 3.0 A/F DIP胶芯	PBT+30%GF	1
序号	产品名称	材质	数量

产品图

PRODUCT CHART DWG

公差一览表

公差一览表		单位		日期		制图		产品料号	
TOLERANCE UNLESS OTHERWISE		UNITS		DATE		DRAWING		PRODUCT PART NO.	
SCALE		SCALE		DATE		CHKD		PRODUCT NO.	
X	±0.30	X'	±5'	XX	2009/10/20	XX	王冠	00405-13A-F003-X	00405-13A-F003-X
X	±0.25	X'	±2'	XX		XX	雷永健	USB3.0 A/F 90度沉板居中型四脚无边L=16.4	
XXX	±0.15	XXX'	±0.5'	XXX		APPD	雷永健	角法	版本
									A0