

ROHS 客户图

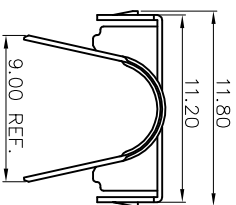

NOTE:
 *ELECTRICAL CHARACTERISTICS:
 1. CONTACT RESISTANCE: 30mΩ MAXIMUM
 2. CONTACT CURRENT RATING: 1.5A
 3. DIELECTRIC WITHSTANDING VOLTAGE: 500V R.M.S.
 4. INSULATION RESISTANCE: 1000 MEGOHMS MIN
 *MECHANICAL CHARACTERISTICS:
 1. MATING FORCE: 3.57kg MAX
 2. UNMATED FORCE: 1.02kg MIN

FRONT SHELL
 BACK SHELL
 CONNECTOR

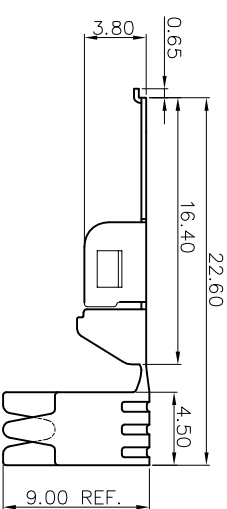
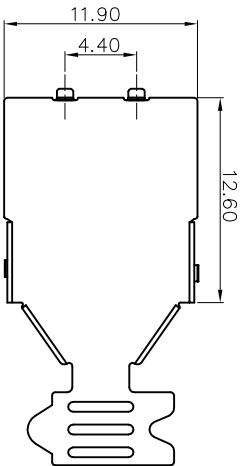
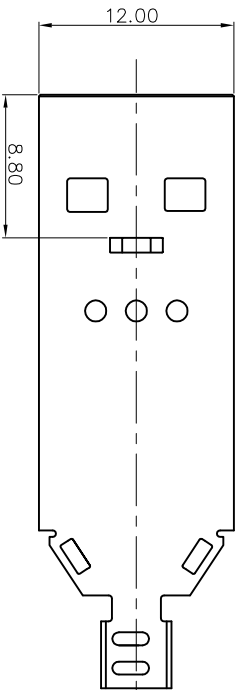
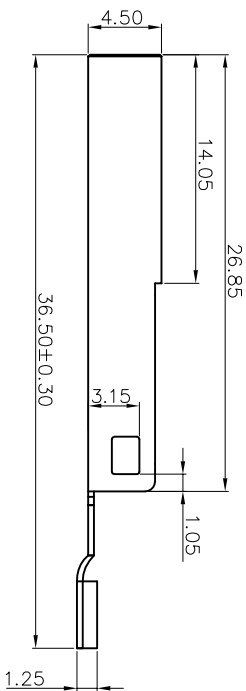
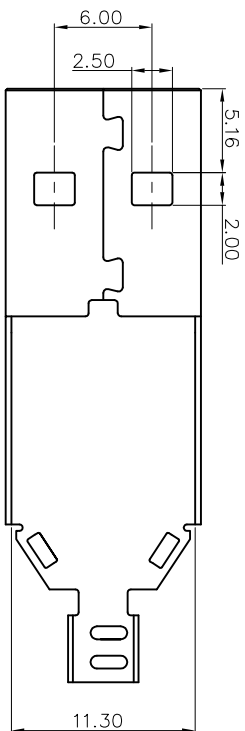
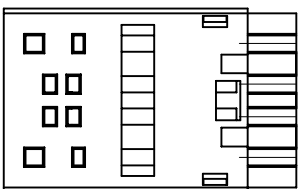
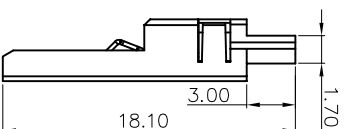
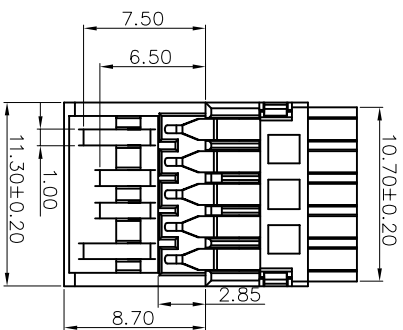
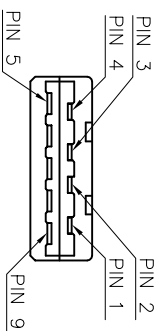

产品图

深圳市鑫风雷电子有限公司

公差一览表 TOLERANCE UNLESS OTHERWISE		单位 UNITS	制图 DRAWING	审核 CHKD	产品料号 PRODUCT PART NO.	产品名称 PRODUCT NO.	角法 VIEW	版本 VER
X	±0.30	X'	±5'	王冠	25005-U3AM003-X	USB3.0 A 公普通三件套0D6.0	⊕	A0
X	±0.25	X'	±2'	雷永健			⊖	
XX	±0.30	XX'	±1'	雷永健			⊕	
XXX	±0.15	XXX'	±0.5'				⊖	

目錄 MAPX	修改內容 MODIFICATION	日期 DATE
A0	NEW	09-10-20