

ROHS 客户图

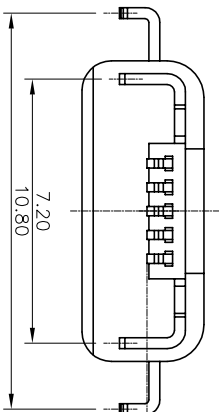

RECOMMENDED PCB LAYOUT
TOP VIEW (Tol:±0.05)

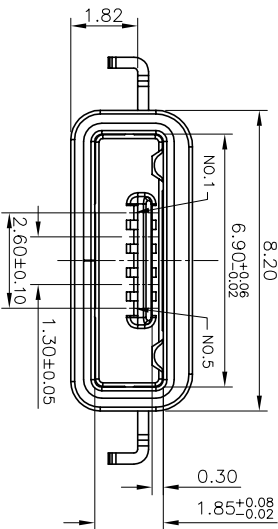
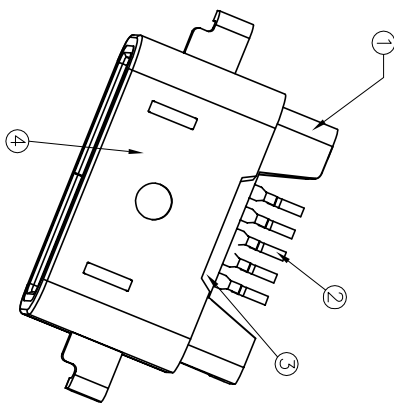
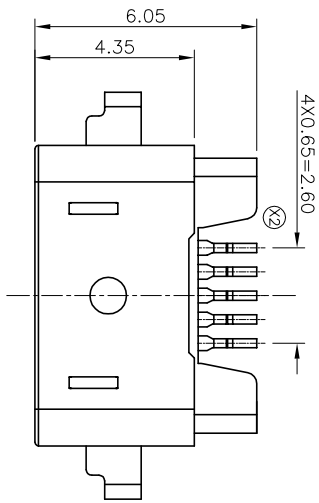
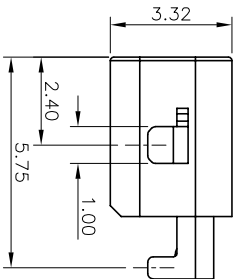
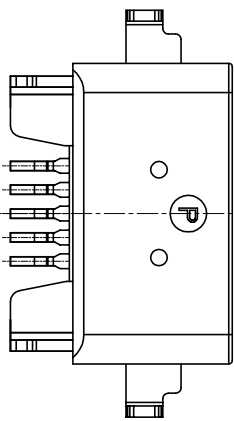
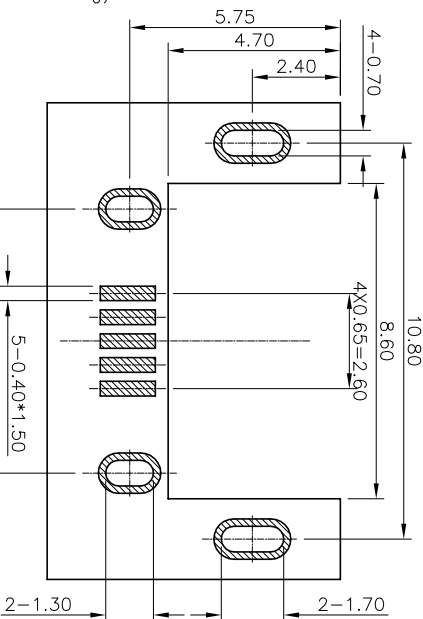

- SPECIFICATIONS:
- ELECTRICAL CHARACTERISTICS:
 - RATING: 3A(PIN1&5),0.5A(PIN2&3&4);
 - CONTACT RESISTANCE: 30 mΩ MAX.(INITIAL);
 - DIELECTRIC WITHSTANDING: 500V AC, MIN.;
 - INSULATION RESISTANCE: 1000MΩ MIN.;
 - DURABILITY: 5,000 CYCLES MIN.;
 - INSERTION FORCE: 3.5Kgf (35N) Max.;
 - EXTRACTION FORCE: 0.5Kgf (5N) Min.;
 - WATER PROOFNESS: THIS PRODUCT IS BASED ON IPX6.
 - PLUG INTERFACE DIMENSIONS CONFORM TO USB2.0 SPEC.
 - PACKAGING: TAPE & REEL.

04	2-in/Mold	1 PCS	HIGH TEMPERATURE PLASTIC	BLACK COLOR, U194W-0;
03	1-in/Mold	1 PCS	HIGH TEMPERATURE PLASTIC	BLACK COLOR, U194W-0;
02	CONTACT	1 PCS	COPPER ALLOY, T=0.20mm	Au: CONTACT AREA 3u", SOLDER AREA: GOLD FLASH.
01	SHELL	1 PCS	STAINLESS STEEL, T=0.30mm	Ni:40~120u"MIN ALL OVER +BLACK BALL
ITEM PART NAME	QTY	MATERIAL	DESCRIPTION	

产品图
PRODUCT CHART DWG
公差一览表
TOLERANCE UNLESS OTHERWISE
单位 MM
比例 1:1
日期 2009/10/20
审核 雷永健
核准 雷永健
制图 王冠
产品料号 00208-UMKF003-X
产品名称 MICRO 5P母座四脚沉板防水 A型
版本 A0

深圳市鑫风雷电子有限公司
Shenzhen xinfenglei Electronic Co., Ltd

Contact Number	Signal Name	Remarks
1#	VBUS	Power
2#	D-	Date-
3#	D+	Date+
4#	ID	Reserve or Ground
5#	GND	Ground