

ROHS 客户图

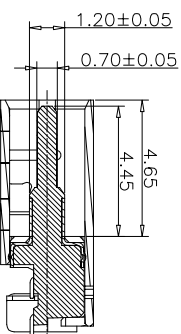

SECTION A-A
SCALE 1:1

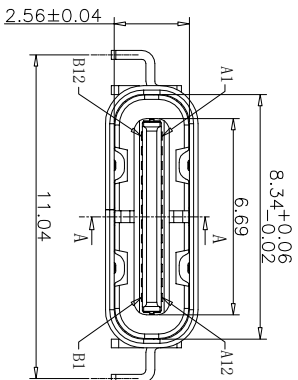
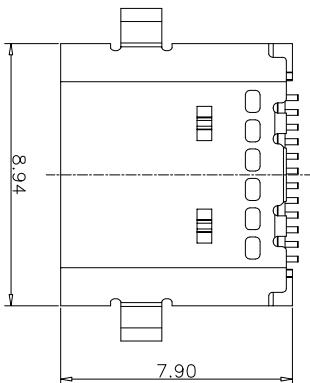
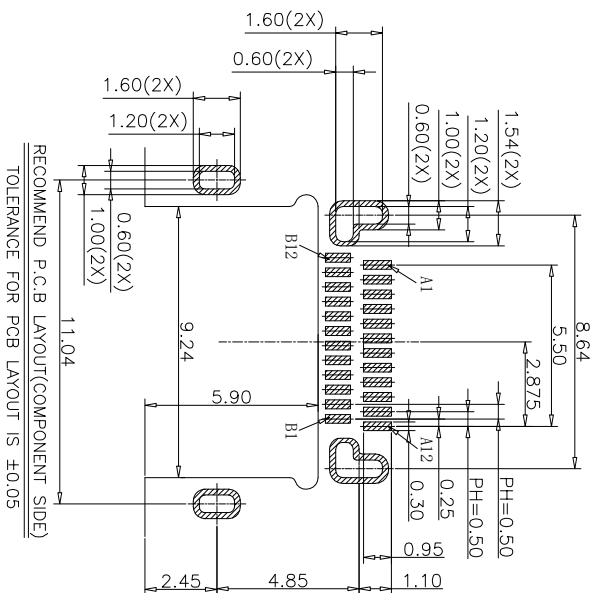

RECOMMEND P.C.B LAYOUT (COMPONENT SIDE)
TOLERANCE FOR PCB LAYOUT IS ±0.05

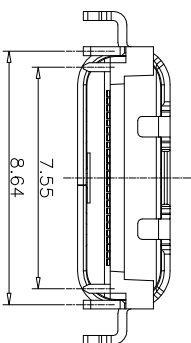
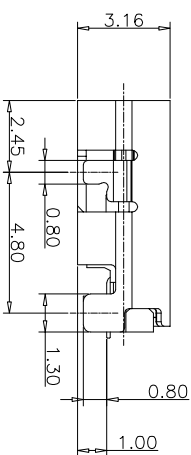

USB TYPE C PIN ASSIGNMENTS

PIN NUMBER	SIGNAL NAME	PIN NUMBER	SIGNAL NAME
A1	GND	B12	GND
A2	TX1+	B11	TX1+
A3	TX1-	B10	TX1-
A4	VBUS	B9	VBUS
A5	CC1	B8	SR02
A6	DP1	B7	DN2
A7	DM1	B6	DP2
A8	SBU1	B5	CC2
A9	VBUS	B4	VBUS
A10	RX2-	B3	TX2-
A11	RX2+	B2	TX2+
A12	GND	B1	GND

TABLE:

NO	PART	QTY	Material
1	SHELL	1	STAINLESS STEEL,NI PLATED
2	CONTACT	24	COPPER ALLOY,TIN/AU/NI PLATED
3	MID PLATE	1	STAINLESS STEEL,NO PLATING
4	EMI	1	STAINLESS STEEL,NI PLATED
5	HOUSING	1	HIGH TEMPERATURE RESISTANT PLASTIC BLACK UL94 V-0

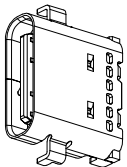

产品图

PRODUCT CHART DWG

公差一览表

TOLERANCE UNLESS OTHERWISE SPECIFIED	公差
X	±0.30
X	±0.25
XX	±0.20
XXX	±0.15

深圳市鑫风雷电子有限公司

Shenzhen xinfenglei Electronics Co., Ltd

单位	MM	比例	日期	制图	审核	核准	产品料号	产品名称	产品方式	联系邮箱
UNITS	MM	1:1	2009/10/20	王冠	雷永健	雷永健	25004-UCAR001-X	Type C 24pin母座双排5MM 沉板1.0L=7.9	PRODUCT NO.	mailto:sale1@xfll.com
SCALE				CHD	LEYONGJIAN	LEYONGJIAN			联系方式	www.xfll.com
DATE				APPD	LEYONGJIAN	LEYONGJIAN			联系邮箱	www.xfll.com

目錄	修改內容	日期
MAPX	MODIFICATION	DATE
A0	NEW	09-10-20