

ROHS

客户图

目錄 MAPX A0	變更內容 MODIFICATION NEW	日期 DATE 09-10-20
------------------	-----------------------------	------------------------

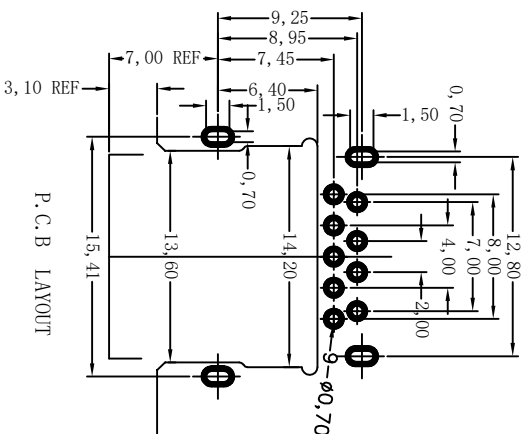
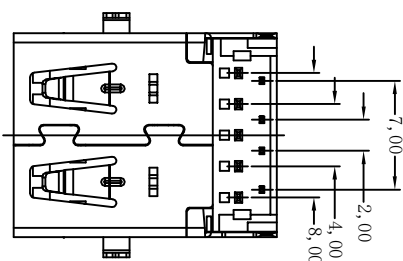
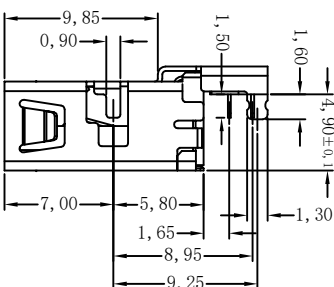
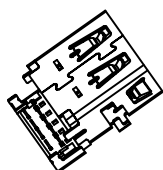
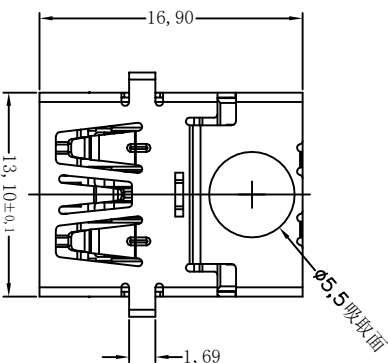
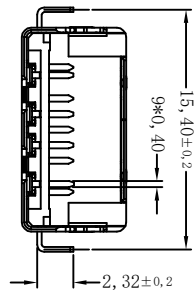

P.C.B LAYOUT

SPECIFICATIONS:  
 Contact current Rating:1.8Amperes.  
 DIELECTRIC Withstanding Voltage:AC 100V at sea level  
 Insulation resistance:1000Megohms Minimum  
 Contact Resistance:30mΩ Max  
 operating Temperature:-35° to+85°

MECHANICAL CHARACTERISTICS:  
 Durability:5000 cycles  
 Mating Force:3.57Kg; Maximum  
 Umating Force:1.0kg; Minimum

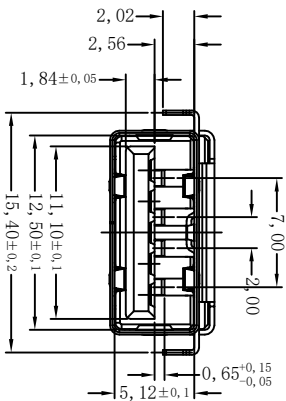

3	胶蕊	1	PBT 30MG	COLOR: BK	
2	端子	9	COPPER ALLOY	GND PLATING	
1	外壳	1	不锈钢		
序号	名称	数量	材料	表面	备注
					Shell

产品图

深圳市鑫风雷电子有限公司  
 Shenzhen xinfenglei Electronic Co., Ltd

公差一览表 TOLERANCE UNLESS OTHERWISE SPECIFIED		单位 UNITS	MM	制图 DRAWING	王冠	产品料号 PRODUCT PART NO.	19004-U3AF001-X
X	±0.30	X'	±5'	比例 SCALE	1:1	审核 CHECK	雷永健
XX	±0.25	X''	±2'	日期 DATE	2009/10/20	核准 APPRO	雷永健
XXX	±0.15	XXX'	±0.5'	角法 VIEW		版本 VER	A0