

ROHS

客户图

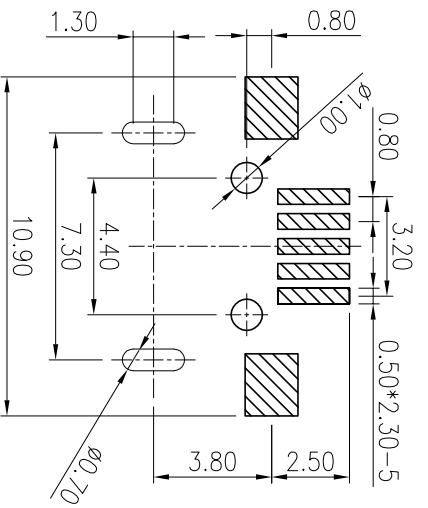

Recommend PCB layout

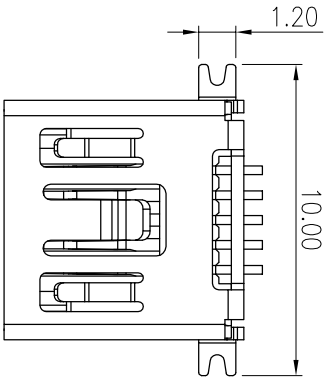
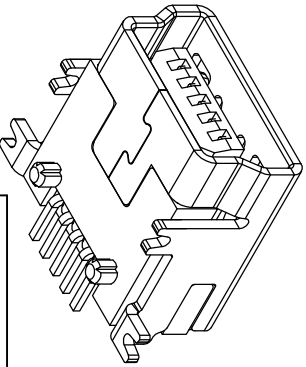
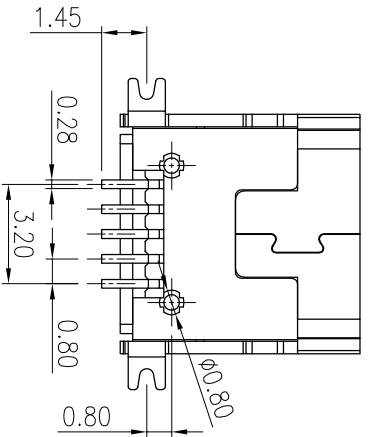
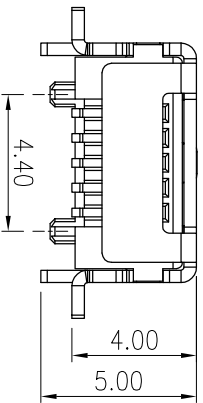
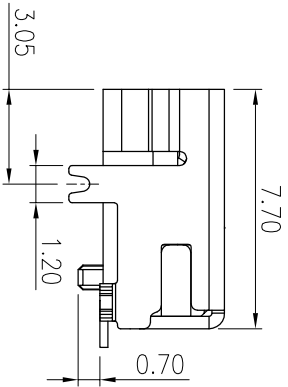
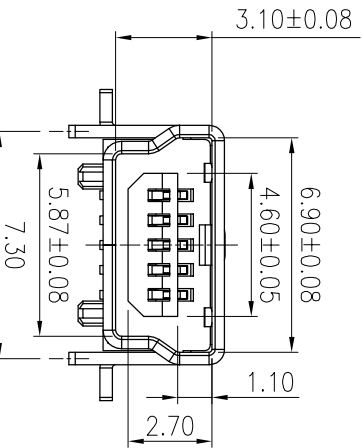

目錄 MAPX	變更內容 MODIFICATION	日期 DATE
A0	NEW	09-10-20

- 注:
1. 材質, 电镀:
 胶体: ICP+30%K, F UL94V-0 黑色
 端子: CS210-BH, T=0, 25mm
 底层镀镍50μ"以上, 接触区镀金
 1μ", 焊接区镀镍80μ";
 2. 机械性能:
 外壳: (2)880, 厚度0.40mm, 镀镍120μ"
 插入力: 35N Max.
 拔出力: 10N Min.
 耐插拔: 5000 次后 3N MIN
 工作温度: -0°C~+80°C
 储存温度: -30°C~80°C
 3. 电性能:
 额定电流: 1.5A Max.
 接触电阻: 30 mΩ Max.
 耐高压: 500V AC Min.
 绝缘电阻: 1000 MΩ Min.

产品图

深圳市鑫风雷电子有限公司

公差一览表 TOLERANCE UNLESS OTHERWISE SPECIFIED		单位 UNITS	MM	制图 DRAWING	王冠	产品料号 PRODUCT PART NO.	11007-UM1F003-X
X	±0.30	X'	±5'	审核 CHKD	雷永健	产品名称 PRODUCT NO.	MINI 5P母前插后贴短体有柱L=7.7
XX	±0.25	XX'	±2'	核准 APPD	雷永健	角法 VIEW	MINI 5P母前插后贴短体有柱L=7.7
XXX	±0.30	XXX'	±1'			版本 VER	A0
	±0.15		±0.5'				