

RoHS 客户图

目錄 MAPX A0	變更內容 MODIFICATION NEW	日期 DATE 09-10-20
------------------	-----------------------------	------------------------

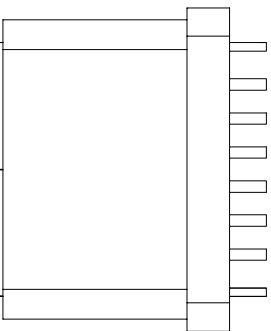

RECOMMENDED P.C.B. LAYOUT
TOLERANCE UNSPECIFIED ±0.05mm

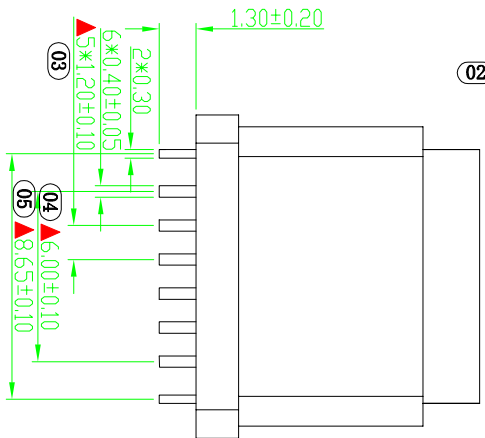
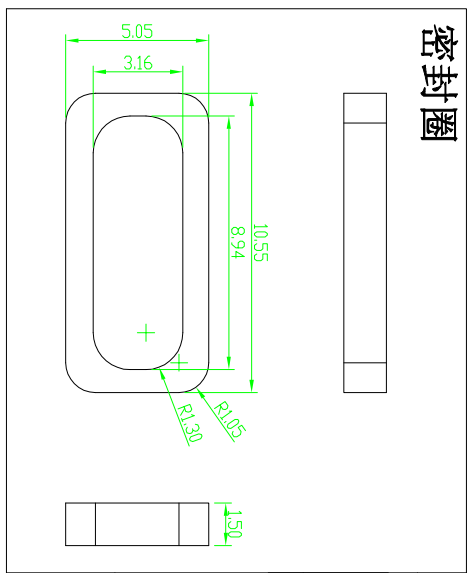
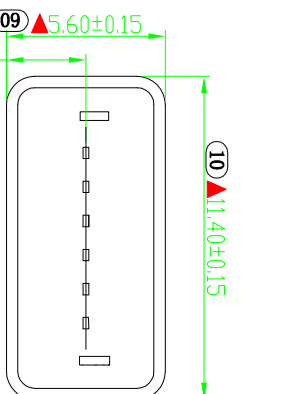
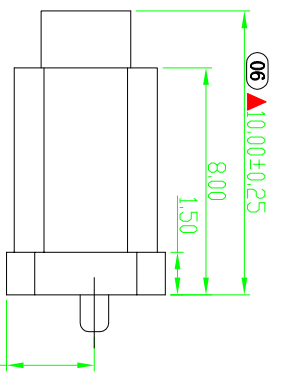
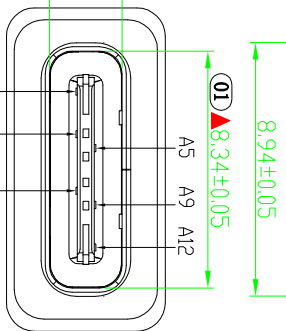
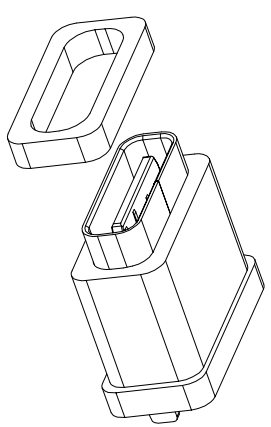
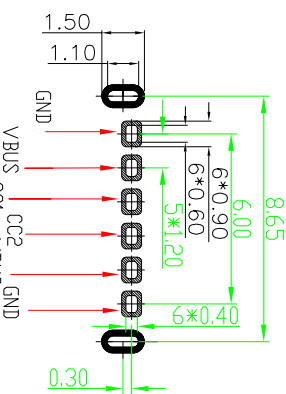

- 备注 (NOTES):
- 电气特性:
 - 1.1. 接触区: 接触电阻40mΩ Max, 允许10mΩ变化量; 测试条件: 20mV, 100mA 下测量.
 - 1.2. 接触电流: 3A VBUS引脚; 1.25A 用于 GND 引脚; 其他引脚为0.25A.
 - 1.3. 额定电压: 20V Max.
 - 1.4. 耐电压: 100 V(Ac) for 1 min.
 - 1.5. 绝缘电阻: 至少100兆欧.
 - 机械性能:
 - 3.1. 插入力: 5-20N
 - 3.2. 拔出力: 6-20N
 - 3.3. 插拔次数: 5000次.
 - 3.4. 推力: 50N min.
 - 3.5. 剥离强度: 150N min.
 - 3.6. 扭曲强度: 0.75Nm
 4. 工作环境: -20°C to +85°C.
 5. 尺寸标注事项:
 - 5.1. 图示有标注“▲”记号者为重点尺寸. 首件检验尺寸为⑩到⑬;
 - 5.2. 图示所有标注“⑨”尺寸均为公称尺寸.
 - 5.3. 图示未标注公差之尺寸参考公差表.
 - 5.4. 图示标注“*”记号之尺寸为标称尺寸.

A12	A11	A10	A9	A8	A7	A6	A5	A4	A3	A2	A1
GND		VBUS		CC1		CC1		VBUS			
B1	B2	B3	B4	B5	B6	B7	B8	B9	B10	B11	B12

产品图

公差一览表
TOLERANCE UNLESS OTHERWISE SPECIFIED

X	±0.30	X'	±5°
X	±0.25	X'	±2°
XX	±0.20	XX'	±1°
XXX	±0.15	XXX'	±0.5°

深圳市鑫风雷电子有限公司

Shenzhen xinfenglei Electronics Co., Ltd

单位 UNITS	mm	比例 SCALE	1:1
制图 DRAWING	王冠 Wangguan	审核 CHKD	雷永健 Leiyongjian
产品料号 PRODUCT PART NO.	00305-UCAR020-X	产品名称 PRODUCT NO.	Type C 6p母座180度插板H=10.0mm水型
日期 DATE	2009/10/20	联系方式 Contact/ web	mailto:sale1@xfli.com www.xfli.com.com