

RoHS 客户图

目録 MAPX A0	设定内容 MODIFICATION NEW	日期 DATE 09-10-20
------------------	-----------------------------	------------------------

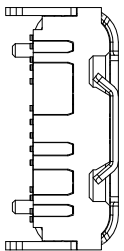
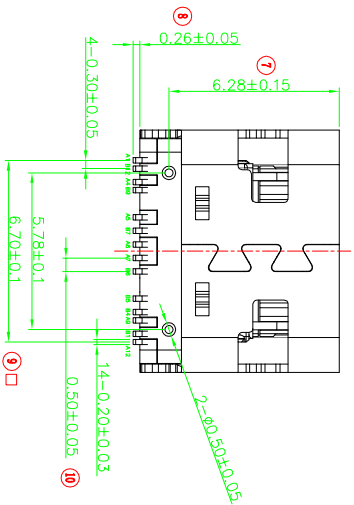
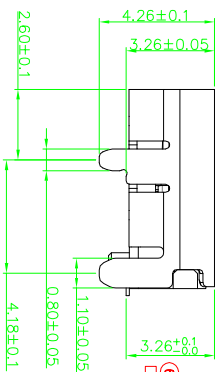
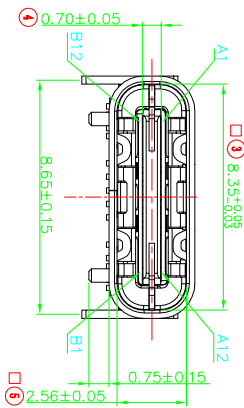
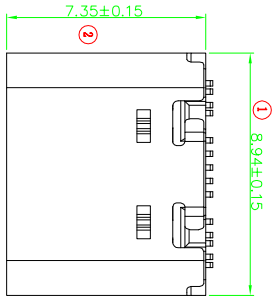

- SPECIFICATIONS:
- MECHANICAL :
 - INSERTION FORCE :5N~20N
 - WITHDRAWAL FORCE :8N~20N AFTER 10,000 CYCLES MATING: 2N MIN.
 - ELECTRICAL :
 - CONTACT CURRENT RATING: 3A .
 - VOLTAGE RATING :30V AC (rms)
 - WITHSTANDING VOLTAGE: 100 VAC FOR 1 MINUTE. INSULATION RESISTANCE: 100 MEGAOHMS MIN.
 - CONTACT RESISTANCE: 40 MILLOHMS MAX.
 - ENVIRONMENTAL :
 - OPERATING TEMPERATURE: -25°C TO +85°C

产品图

深圳市鑫风雷电子有限公司

公差一览表 TOLERANCE UNLESS OTHERWISE SPECIFIED		单位 UNITS	比例 SCALE	日期 DATE	制图 DRAWING	审核 CHKD	核准 APPD	产品料号 PRODUCT PART NO.	产品名称 PRODUCT NO.	角法 VIEW	版本 VER
X	±0.30	X'	±5'	2009/10/20	王冠	雷永健	雷永健	13001-UCAF009-X	TYPE C母座单排14P	TYPE C母座单排14P	A0
X	±0.25	X'	±2'								
XX	±0.30	XX'	±1'								
.XXX	±0.15	.XXX'	±0.5"								

RoHS 客户图

目錄 MAPX A0	變更內容 MODIFICATION NEW	日期 DATE 09-10-20
------------------	-----------------------------	------------------------

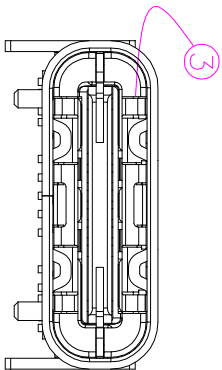
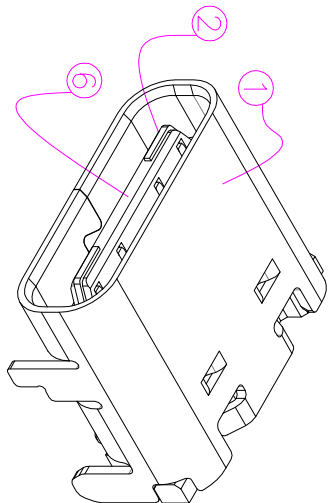
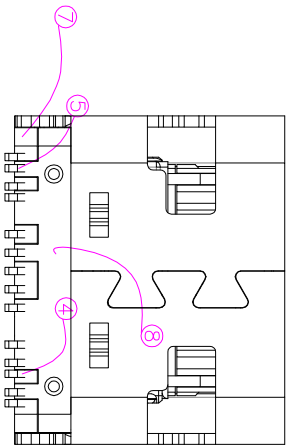
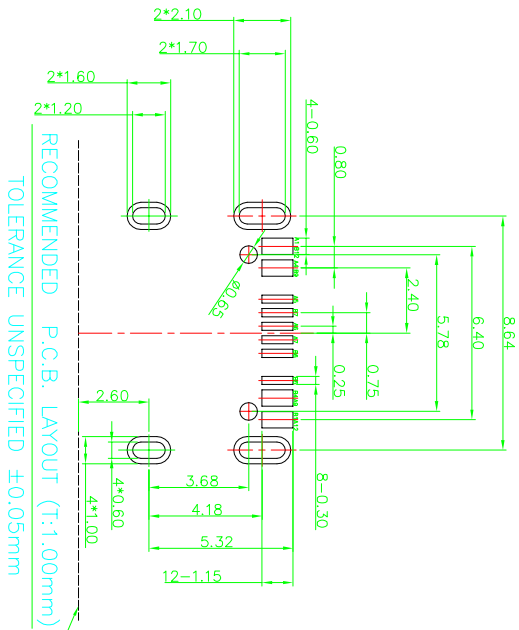

1	A	B
2	GND	12 GND
3		10
4	VBUS	9 PWR
5	CC	8 SBU2
6	D-	7 D+
7	D+	6 D-
8	SBU1	5 Vconn
9	VBUS	4 PWR
10		3
11		2
12	GND	1 GND

1	THERMOPLASTIC UL94V-0	DIP HOUSING	⑧
1	THERMOPLASTIC UL94V-0	LATCH HOUSING	⑦
12	COPPER ALLOY	DIP CONNECTOR	⑨
12	COPPER ALLOY	SMT CONNECTOR	④
1	SUS	SMT CONNECTOR	⑤
1	SUS	LATCH	②
1	SUS	SHELL	③
OTHERS	MATERIAL	NAME	NO

产品图

深圳市鑫风雷电子有限公司

公差一览表		单位	MM	制图	王冠	产品料号	13001-UCAF009-X
TOLERANCE UNLESS OTHERWISE		UNITS		DRAWING		产品名称	TYPE C母座单排14P
X	±0.30	X'	±5'	审核	雷永健	角法	
.XX	±0.25	.X'	±2'	核准	雷永健	比例	1:1
.XX	±0.30	.XX'	±1'	日期	2009/10/20	SCALE	
.XXX	±0.15	.XXX'	±0.5'	日期		DATE	

RoHS 客户图

目錄 MAPX A0	變更內容 MODIFICATION NEW	日期 DATE 09-10-20
------------------	-----------------------------	------------------------

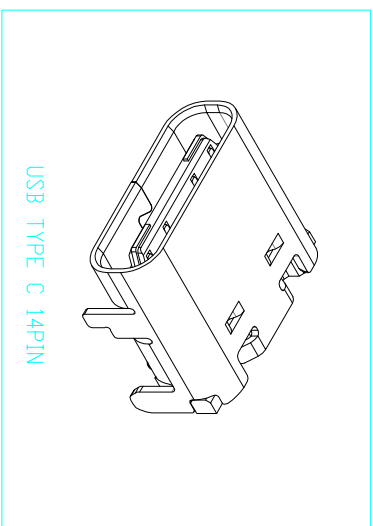
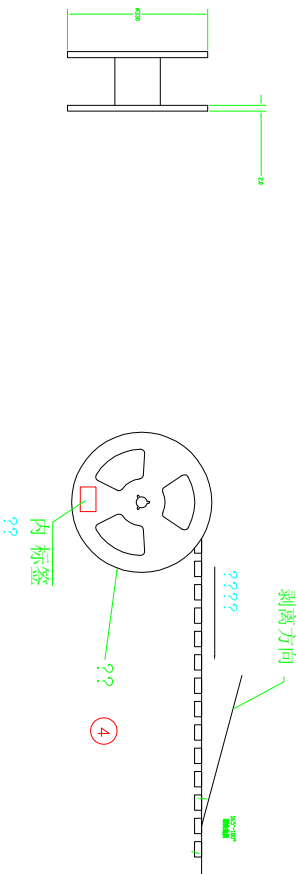
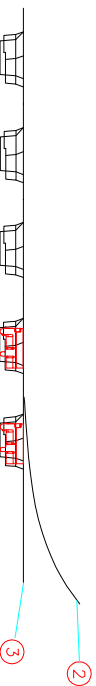
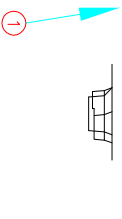
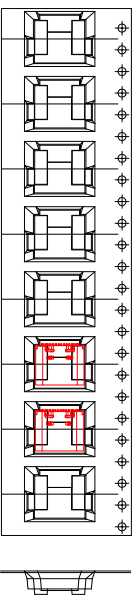
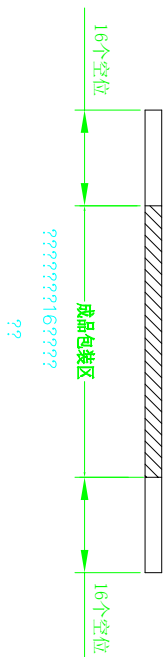

TABLE A

??	??	??	??
①	USB TYPE C 16 pin		10 K
②	???	GP PET, W=21.3mm, 热融性	12.38*10
③	??	GP PS? W=24mm F=12mm T=0.36mm(I?/A2.38h) 2.38*10	
④	??	?? 3.30*24.0???	10PCS
⑤	??	390*390*3mm	2PCS
⑥	???	320(90+140+90)*300mm	4PCS
⑦	??	330*330*305mm K=K	1PCS
⑧	???	600*600*0.15	1PCS

产品图

深圳市鑫风雷电子有限公司

PRODUCT CHART DWG

公差一览表

TOLERANCE UNLESS OTHERWISE	UNIT	SCALE	DATE	制图	审核	核准	产品料号	产品名称	角法	版本
X ±0.30	X'	±5'	2009/10/20	王冠	雷永健	雷永健	13001-UCAF009-X	TYPE C母座单排14P	⊕	A0
X ±0.25	X'	±2'								
XX ±0.30	XX'	±1'								
.XXX ±0.15	XXX'	±0.5'								

RoHS 客户图

目錄 MAPX A0	變更內容 MODIFICATION NEW	日期 DATE 09-10-20
------------------	-----------------------------	------------------------

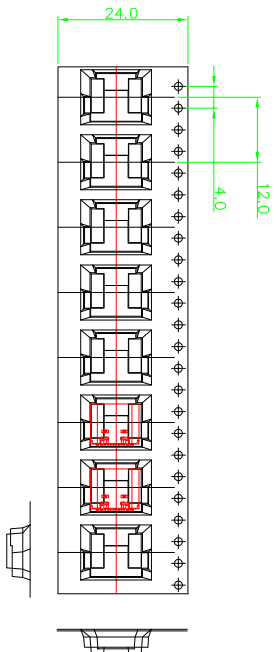

1 产品入载带示意图

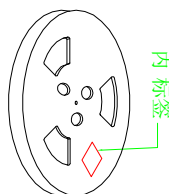

2 卷盘贴标签示意图

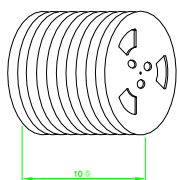

3 10盘产品叠层示意图

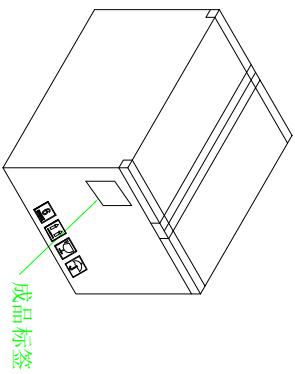

6 外箱封箱示意图

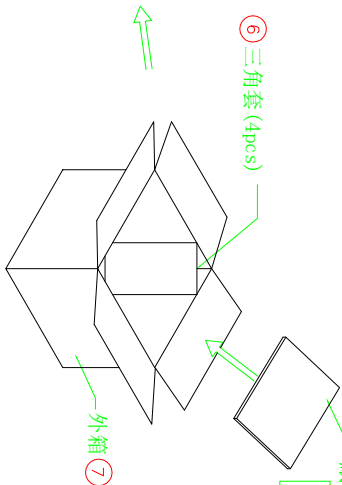

5 产品入外箱示意图



6 三角套 (4pcs)

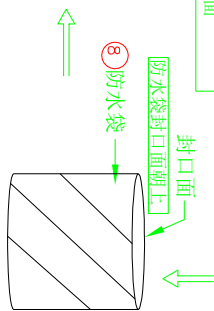

8 防水袋

4 10盘产品入防水袋示意图



干燥剂

- 包装说明:
1. 将检验好的成品;SMT朝下放入载带底部;每卷装1000PCS产品;具体如图一所示
 2. 将包装好的产品;每盘必需贴上内标签;具体如图二所示
 3. 将贴好内标签的产品每10盘叠一层装入防水袋中并加一包干燥剂;装好后将防水袋封好;具体如图三图四所示
 4. 先将1pcs平卡放入纸箱底部;然后将装好产品的防水袋装入纸箱中;防水袋热熔封口,封口面需朝上;并将4PCS三角套分别装入4个角;如图五所示
 5. 装好后将1pcs平卡放入纸箱最上面并封好纸箱及贴好相关标签;具体如图六所示;(产品包装的标签,如客户有要求,请按客户要求包装出货)
 6. 载带前面和后面各留16PCS空格
 7. COVER与CARRY剥离力:50-125g,速度:300mm/分钟左右,剥离角度:165°-180°

产品图

深圳市鑫风雷电子有限公司

公差一览表 TOLERANCE UNLESS OTHERWISE		单位 UNITS		比例 SCALE		日期 DATE	
X	±0.30	X'	±5'	1:1	2009/10/20	王冠	13001-UCAF009-X
X	±0.25	X'	±2'			雷永健	TYPE C母座单排14P
XX	±0.30	XX'	±1'			雷永健	版本 VER
XXX	±0.15	XXX'	±0.5'				A0