

ROHS 客户图

A5	CC1	B12	GND
A9	VBUS	B9	VBUS
A12	GND	B5	CC2
PIN	SIGNAL NAME	PIN	SIGNAL NAME

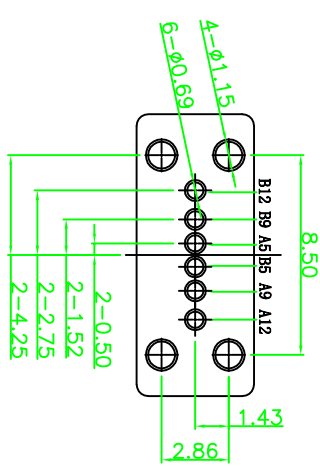
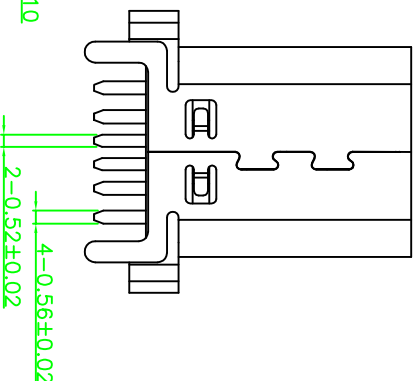
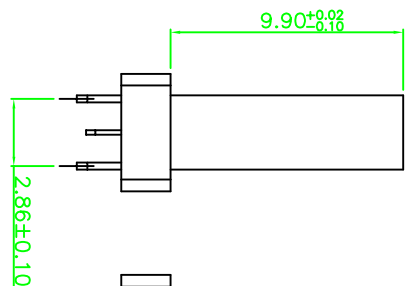
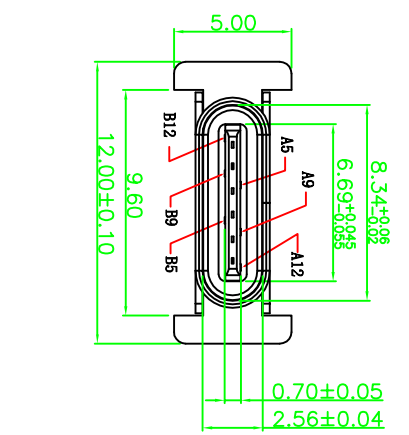
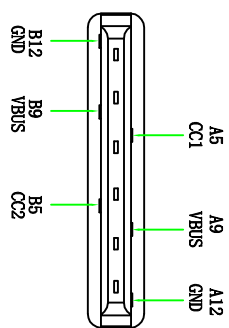
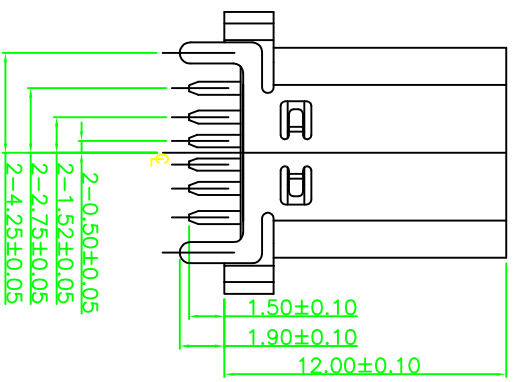

RECOMMENDED P.C.B. LAYOUT
TOLERANCE UNSPECIFIED ±0.05mm

目錄 MAPX 40	設定內容 MODIFICATION NEW	日期 DATE 09-10-20
------------------	-----------------------------	------------------------

NOTES:
特性: Specifications
电器 Electrical:

接触阻抗: 初始最大不超过40mΩMax, 测试后变化值不超过10mΩMax
 耐电压: AC200V 60S/MIN, 0.5mA Max; DC500V, 60S/MIN, 100QMax
 绝缘阻抗: 100M ohms MIN
 额定电流: 2A MAX
 额定电压: 10V MAX

材料: Material:
 Molding: LCP料黑色耐高温塑胶
 端子: C2680 T=0.20mm
 外壳: SUS201 T=0.30mm

电镀规格:
 端子: 半金锡, 接触点镀金1u", 焊线处镀雾锡40-80u".
 外壳: 镀镍80u"
 环保要求: ROHS, REACH标准.

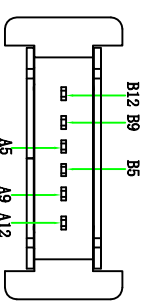

PART NO: 8001F-0600012-A
 SERISE: TYPE C
 Receptacle
 serial number
 Variable

产品图 PRODUCT CHART DWG		公差一览表 TOLERANCE UNLESS OTHERWISE SPECIFIED	
X	±0.30	X'	±5°
X	±0.25	X'	±2°
.XX	±0.30	.XX'	±1°
.XXX	±0.15	.XXX'	±0.5°

深圳市鑫风雷电子有限公司
 Shenzhen xinfenglei Electronic Co., Ltd

单位 UNITS	MM	制图 DRAWING	王冠	产品料号 PRODUCT PART NO.	8001F-0600012-A
比例 SCALE	1:1	审核 CHECK	雷永健	产品名称 PRODUCT NAME	TYPE C 6P母座180度插板H=12.0
日期 DATE	2009/10/20	核准 APPD	雷永健	角法 VIEW	
				版本 VER	A0

THIS DRAWING CONTAINS INFORMATION THAT IS PROPRIETARY TO XINFENGLI ELECTRONIC CO.,LTD AND SHOULD NOT BE USED WITHOUT WRITTEN PERMISSION