

# ROHS 客户图

|                  |                             |                        |
|------------------|-----------------------------|------------------------|
| 目錄<br>MAPX<br>40 | 變更內容<br>MODIFICATION<br>NEW | 日期<br>DATE<br>09-10-20 |
|------------------|-----------------------------|------------------------|

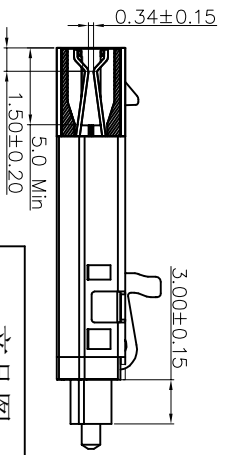
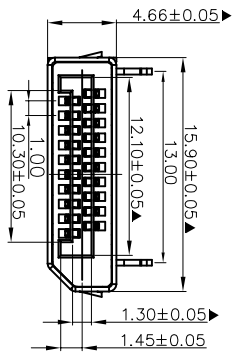
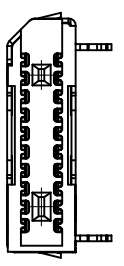
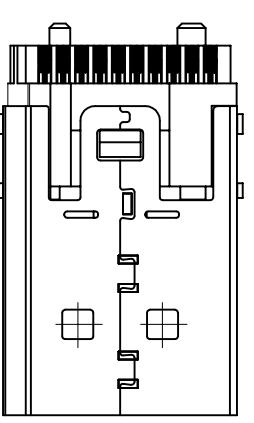
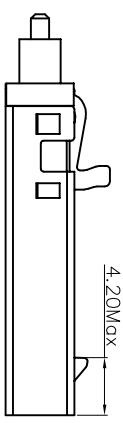
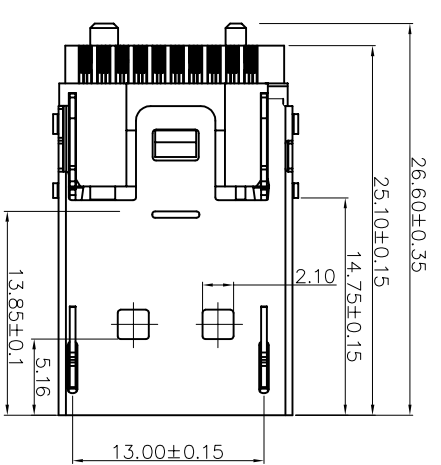

备注:  
 材料: 主体按芯、LCP黑色 UL94V-0, 符合ROHS2.0 & HF  
 后 塞、LCP黑色 UL94V-0, 符合ROHS2.0 & HF  
 端 子、C5191R/H T=0.25  
 外 壳、SPCC T=0.3  
 电镀: 端子、铜底60u"Min, 焊线区锡100u"Min, 接触区镀金见附表”。  
 电气: 接 触、铜打底, 镍80u"Min  
 绝 缘、30mΩMax  
 耐 压、500 DC 1分钟 ▲100MΩ MIN  
 机械: 插入力、45N Max  
 拔出力、10N Min 寿命5000次, 插拔寿命后接  
 触电阻最大变化值不能超过10mΩ。  
 盐雾24h  
 带 为重点管控尺寸。

PART NO: 8007M-0000005-X  
 SERISE: DP  
 Receptacle  
 serial number  
 Variabler

|                          |       |                                     |       |
|--------------------------|-------|-------------------------------------|-------|
| 产品图<br>PRODUCT CHART DWG |       | 公差一览表<br>TOLERANCE UNLESS OTHERWISE |       |
| X                        | ±0.30 | X'                                  | ±5°   |
| X                        | ±0.25 | X'                                  | ±2°   |
| .XX                      | ±0.20 | .XX'                                | ±1°   |
| .XXX                     | ±0.15 | .XXX'                               | ±0.5° |

|             |            |               |                    |                         |   |
|-------------|------------|---------------|--------------------|-------------------------|---|
| 单位<br>UNITS | MM         | 制图<br>DRAWING | 王冠<br>Wangguang    | 产品料号<br>PRODUCT PART NO | 8007M-0000005-X                         |
| 比例<br>SCALE | 1:1        | 审核<br>CHECK   | 雷永健<br>Leiyongjian | 产品名称<br>PRODUCT NO      | 大芯 20P 公头 六件式 有卡钩 焊线式 主体                |
| 日期<br>DATE  | 2009/10/20 | 核准<br>APPD    | 雷永健<br>Leiyongjian | 联系方式<br>CONTACT INFO    | mailto:sale1@xf1.com<br>www.xf1.com.com |

深圳市鑫风雷电子有限公司  
 Shenzhen xinfenglei Electronics Co., Ltd

THIS DRAWING CONTAINS INFORMATION THAT IS PROPRIETARY TO XINFENGLI ELECTRONIC CO.,LTD AND SHOULD NOT BE USED WITHOUT WRITTEN PERMISSION



# ROHS 客户图

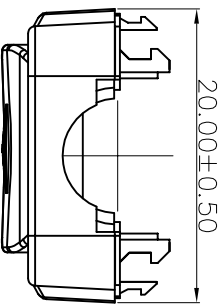
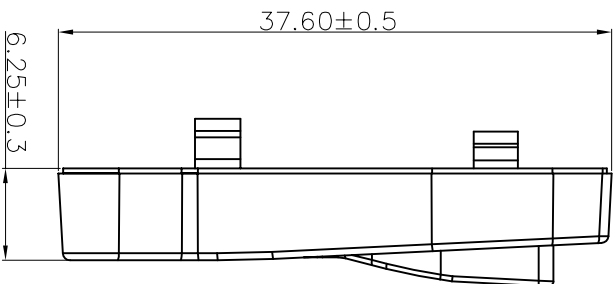
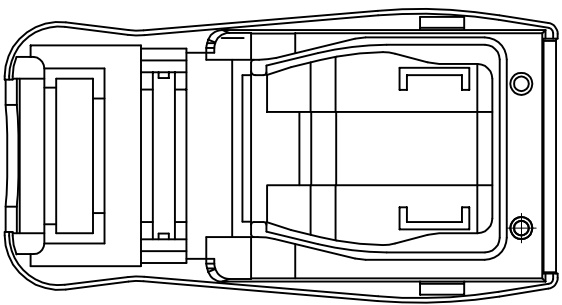
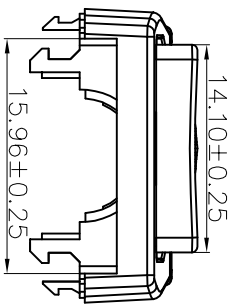

材料: Material:

1. Housing: PC+ABS
2. 上下盖以适配为准
3. 带 ▲ 为重点尺寸
4. 白色XM客户料号2010110-802

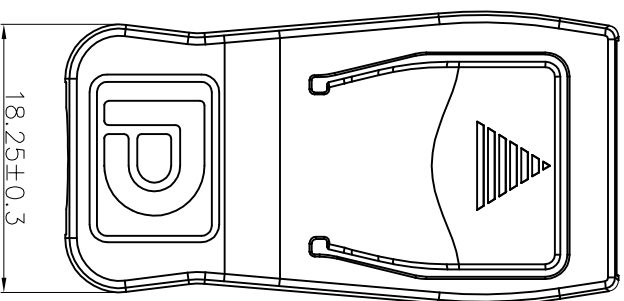

| 目錄<br>MAPX | 變更內容<br>MODIFICATION | 日期<br>DATE |
|------------|----------------------|------------|
| 40         | NEW                  | 09-10-20   |

| 产品图<br>PRODUCT CHART DWG |       | 公差一览表<br>TOLERANCE UNLESS OTHERWISE |       |
|--------------------------|-------|-------------------------------------|-------|
| X                        | ±0.30 | X'                                  | ±5°   |
| X                        | ±0.25 | X''                                 | ±2°   |
| .XX                      | ±0.20 | .XX'                                | ±1°   |
| .XXX                     | ±0.15 | .XXX'                               | ±0.5° |

|             |            |               |                    |                          |   |
|-------------|------------|---------------|--------------------|--------------------------|---|
| 单位<br>UNITS | MM         | 制图<br>DRAWING | 王冠<br>Wangguang    | 产品料号<br>PRODUCT PART NO. | 8007M-0000005-X                                 |
| 比例<br>SCALE | 1:1        | 审核<br>CHECK   | 雷永健<br>Leiyongjian | 产品名称<br>PRODUCT NO.      | 5件式DP 外塑壳上盖(卡钩款)                                |
| 日期<br>DATE  | 2009/10/20 | 核准<br>APPD    | 雷永健<br>Leiyongjian | 联系方式<br>Master/ web      | mailbox: sale1@xf1.com.com<br>www. xf1.com. com |

深圳市鑫风雷电子有限公司  
Shenzhen xinfenglei Electronics Co., Ltd

THIS DRAWING CONTAINS INFORMATION THAT IS PROPRIETARY TO XINFENGLI ELECTRONIC CO.,LTD AND SHOULD NOT BE USED WITHOUT WRITTEN PERMISSION

# ROHS 客户图

|                  |                             |                        |
|------------------|-----------------------------|------------------------|
| 目錄<br>MAPX<br>40 | 變更內容<br>MODIFICATION<br>NEW | 日期<br>DATE<br>09-10-20 |
|------------------|-----------------------------|------------------------|

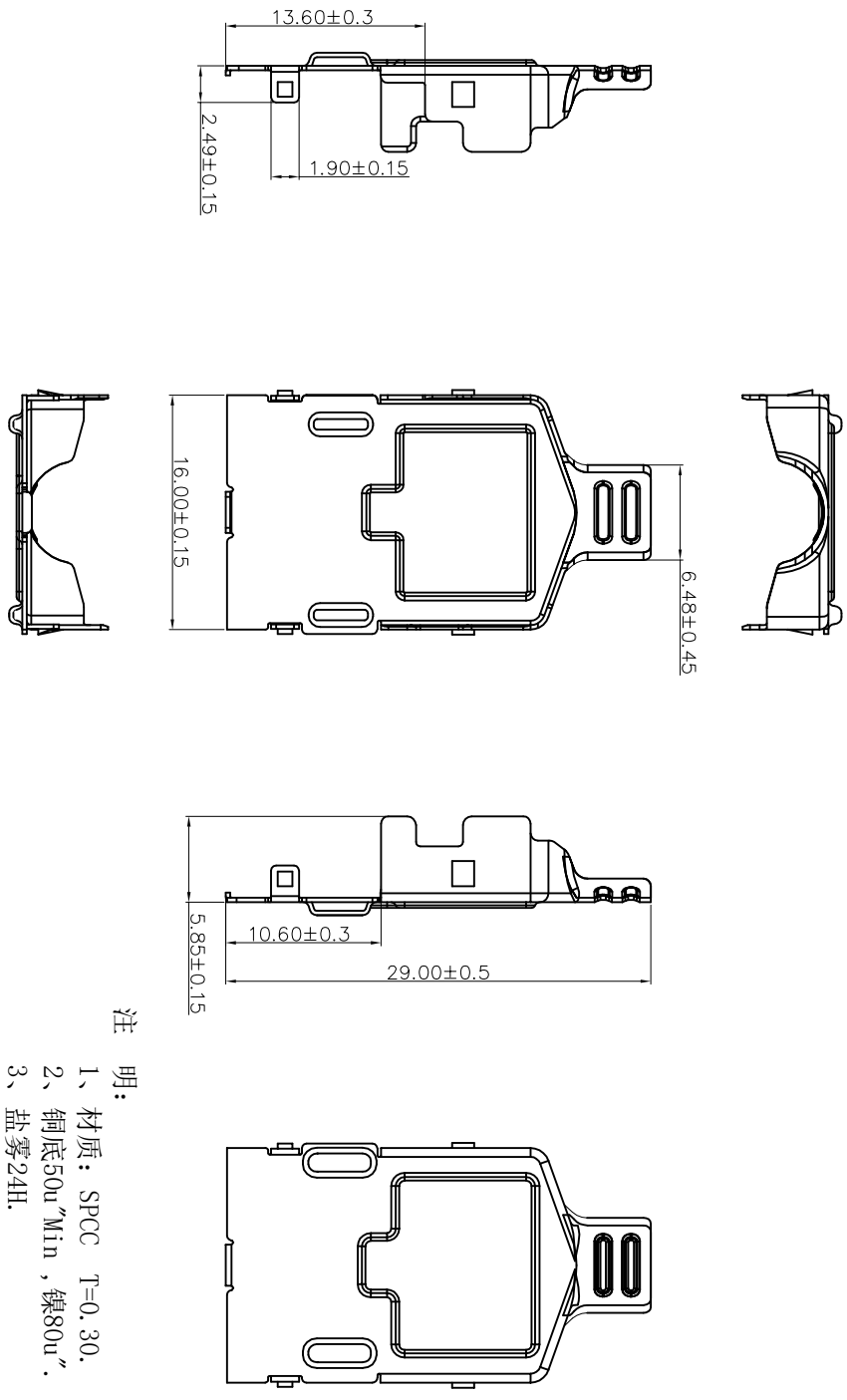

注 明:

- 1、材质：SPCC T=0.30.
- 2、铜底50u"Min，镍80u".
- 3、盐雾24H.
- 4、上下盖以适配插头为准.

|                                     |            |  |   |
|-------------------------------------|------------|--|---|
| 产品图<br>PRODUCT CHART DWG            |            | 深圳市鑫风雷电子有限公司<br>Shenzhen xinfenglei Electronics Co., Ltd |   |
| 公差一览表<br>TOLERANCE UNLESS OTHERWISE |            | 单位<br>UNITS  | 制图<br>DRAWING                               |
| X                                   | ±0.30      | X  | ±5°   |
| X                                   | ±0.25      | X  | ±2°   |
| .XX                                 | ±0.20      | .XX  | ±1°   |
| .XXX                                | ±0.15      | .XXX   | ±0.5°                                       |
| 日期<br>DATE                          | 2009/10/20 | 核准<br>APPD   | 雷永健<br>Leyongjian                           |
| 比例<br>SCALE                         | 1:1        | 产品料号<br>PRODUCT PART NO                                  | 8007M-0000005-X                             |
| 日期<br>DATE                          | 2009/10/20 | 产品名称<br>PRODUCT NAME                                     | DP号口铁上盖取消卡钩孔                                |
| 日期<br>DATE                          | 2009/10/20 | 联系方式<br>CONTACT INFO                                     | mailto:salel@xflecom.com<br>www.xflecom.com |

THIS DRAWING CONTAINS INFORMATION THAT IS PROPRIETARY TO XINFENGLI ELECTRONIC CO.,LTD AND SHOULD NOT BE USED WITHOUT WRITTEN PERMISSION



# RoHS 客户图

|                  |                             |                        |
|------------------|-----------------------------|------------------------|
| 目錄<br>MAPX<br>40 | 變更內容<br>MODIFICATION<br>NEW | 日期<br>DATE<br>09-10-20 |
|------------------|-----------------------------|------------------------|

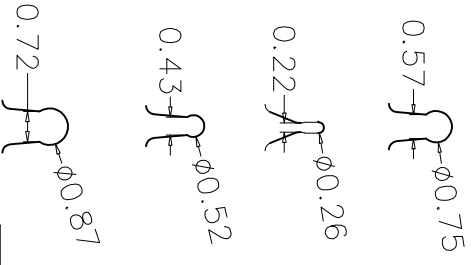
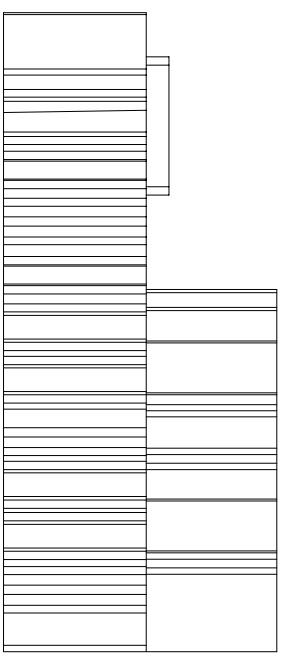
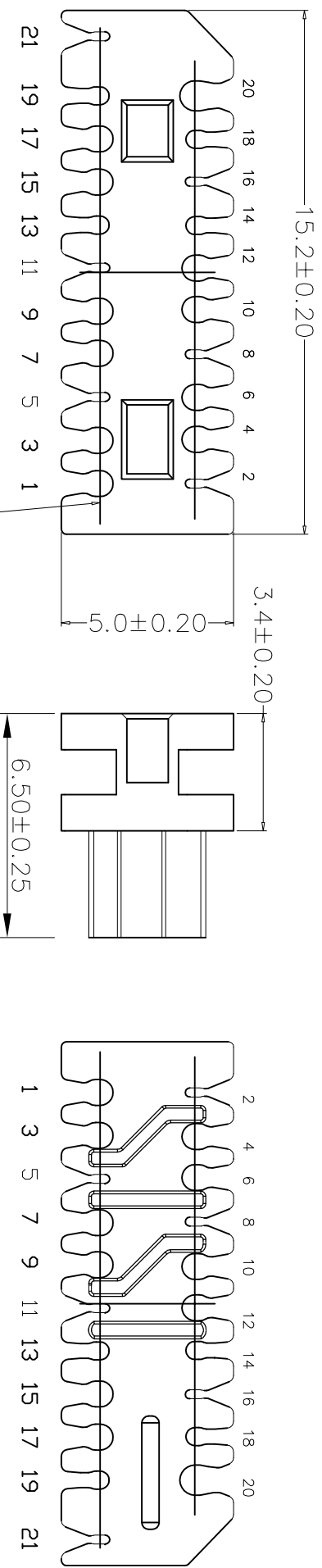

- 槽: 1、3、7、9、15、17、4、6、10、12
- 槽: 5、11、21、2、8、16
- 槽: 13、19、14、18
- 槽: 20

- 备注:
1. 材质: PA66 黑色;
  2. 未注R角为0.10mm;
  3. 毛边不得大于0.05mm;
  4. 线夹以实配为准。

## 产品图

|                                     |                   |  |                       |
|-------------------------------------|-------------------|--|-----------------------|
| PRODUCT CHART DWG                   |                   | 深圳市鑫风雷电子有限公司<br>Shenzhen xinfenglei Electronics Co., Ltd |                       |
| 公差一览表<br>TOLERANCE UNLESS OTHERWISE |                   | 单位<br>UNITS  | 制图<br>DRAWING         |
| X                                   | ±0.30             | X'   | ±5°                   |
| X                                   | ±0.25             | X'   | ±2°                   |
| .XX                                 | ±0.20             | .XX'   | ±1°                   |
| .XXX                                | ±0.15             | .XXX'  | ±0.5°                 |
| 日期<br>DATE                          | 2009/10/20        | 日期<br>DATE   | 2009/10/20            |
| 比例<br>SCALE                         | 1:1               | 比例<br>SCALE  | 1:1                   |
| 日期<br>DATE                          | 2009/10/20        | 日期<br>DATE   | 2009/10/20            |
| 核准<br>APPD                          | 雷永健<br>Leyongjian | 核准<br>APPD   | 雷永健<br>Leyongjian     |
| 产品料号<br>PRODUCT PART NO             | 8007M-0000005-X   | 产品名称<br>PRODUCT NO                                       | DP五件式焊线式线夹30#(7345-1) |
| 联系方式<br>Macthor/ web                | www.xf1.com.com   | 联系方式<br>Macthor/ web                                     | www.xf1.com.com       |

THIS DRAWING CONTAINS INFORMATION THAT IS PROPRIETARY TO XINFENGLI ELECTRONIC CO.,LTD AND SHOULD NOT BE USED WITHOUT WRITTEN PERMISSION