

RoHS 客户图

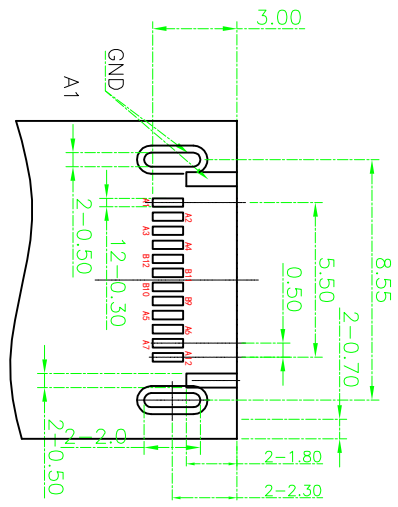

Recommended PCB layout
tolerance ±0.05

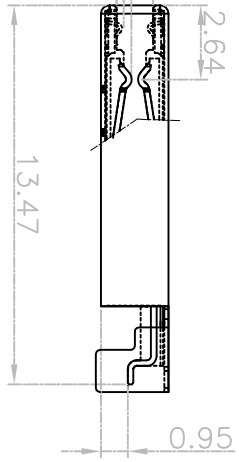
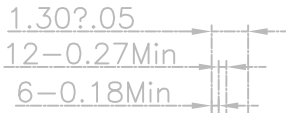
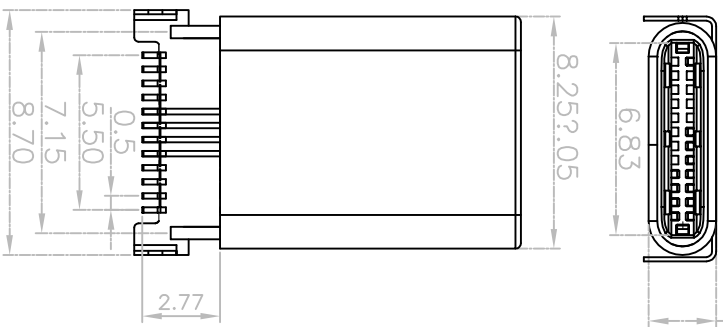
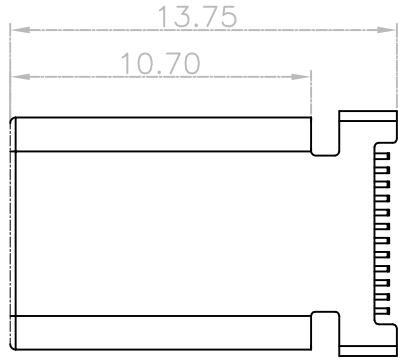
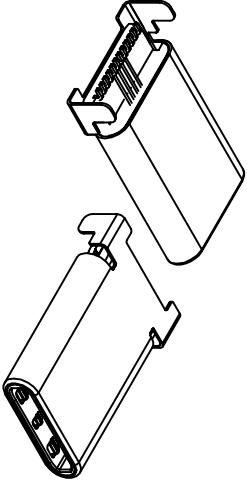
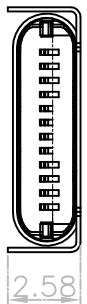

目錄 MAPX	變更內容 MODIFICATION	日期 DATE
A0	NEW	09-10-20

- NOTE:
1. MATERIAL:
 - 1.1 INSULATOR: HIGH TEMPERATURE PLASTIC UL 94 V-0;
 - 1.2 CONTACT: COPPER ALLOY(T=0.20mm)
 - 1.3 SHELL: STEEL(T=0.15mm)
 2. ELECTRICAL CHARACTERISTICS:
 - 2.1 CONTACT RESISTANCE: 40mΩ Max FOR INITIAL, 10mΩ CHANGE AFTER TEST, MEASURE AT 20mV, 100mA.
 - 2.2 CONTACT CURRENT RATING: 5A Max FOR VBUS/GND PIN; 0.9A Max FOR other PIN.
 - 2.3 DIELECTRIC WITHSTANDING VOLTAGE: 100V AC R.M.S.
 - 2.4 INSULATION RESISTANCE: 100MΩ/MIN
 - 2.5 OPERATING TEMPERATURE: -40°C~85°C
 3. MECHANICAL CHARACTERISTICS:
 - 3.1 MATING FORCE: 5~20 N.
 - 3.2 UNMATED FORCE: 6~20N AFTER TEST
 - 3.3 DURABILITY: 10,000 CYCLES, 500 CYCLES/H
 4. PLATING:
 - CONTACT: CONTACT AREA PLATING Au1u", SOLDER AREA PLATING 80u" MATTING Sn.
 - SHELL:50u"Ni PLATING OVER ALL

PART NO: 8001M-1200004-B

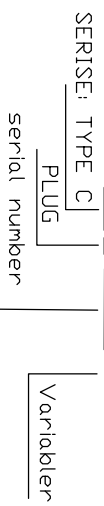

A12	A11	A10	A9	A8	A7	A6	A5	A4	A3	A2	A1
GND			D-	D+	CC	Vbus	TX-	TX+	GND		
B1	B2	B3	B4	B5	B6	B7	B8	B9	B10	B11	B12
					Vbus	RX1-	RX1+	GND			

产品图 PRODUCT CHART DWG		深圳市鑫风雷电子有限公司 Shenzhen xinfenglei Electronic Co., Ltd	
公差一览表 TOLERANCE UNLESS OTHERWISE		单位 UNITS	MM
X	±0.30	X'	±5'
X	±0.25	X'	±2'
XX	±0.30	XX'	±1'
XXX	±0.15	XXX'	±0.5'
比例 SCALE	1:1	日期 DATE	2009/10/20
制图 DRAWING	王冠 Wangguan	产品料号 PRODUCT PART NO	8001M-1200004-B
审核 CHECK	雷永健 Leiyongjian	产品名称 PRODUCT NO	TYPE C 12P公头拉伸壳沉数0.95 L=1.75 外壳DIP
核准 APPD	雷永健 Leiyongjian	角法 VIEW	版本 VER
			A0

加固定块

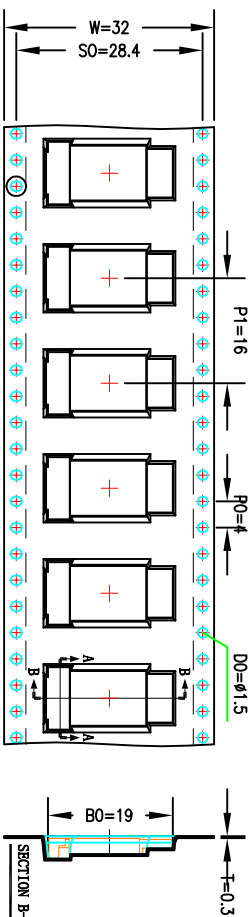
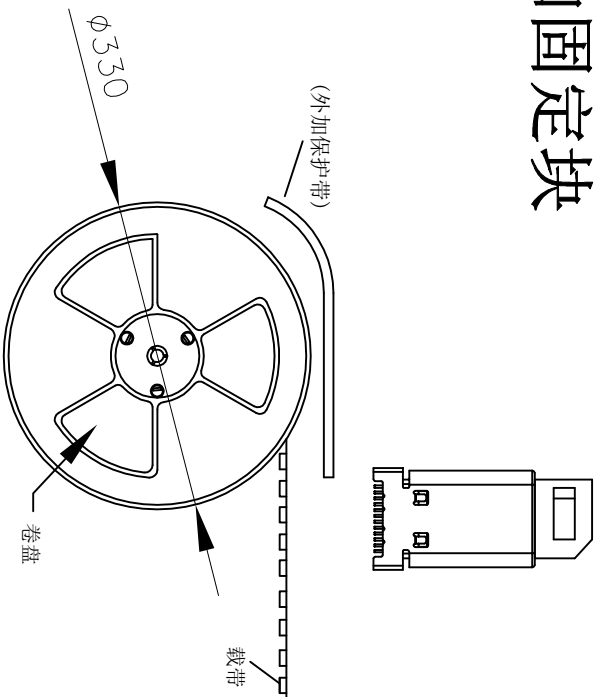

- 备注:
- 1.每卷前后各空15PCS,尾部用美纹胶纸封住.
 - 2.将产品放入载带内,共放1000PCS,放满盘后,再卷一圈保护带.
 - 3.每5卷盘装入一个纸箱内;保护带最后重叠约50mm,用美纹胶纸将其封住
 - 4.在搬运过程中要轻拿轻放.
 - 5.在运输中不可堆放过高,不可有重压现象.
 - 6.跌落测试条件:

成品箱子从1.5米高自由落体(三棱六面一角)检验项目:

- 1.产品不可跑出下带凹槽.
- 2.产品不可有摔伤,变形.
- 3.外箱及内包装材料不可严重破损.

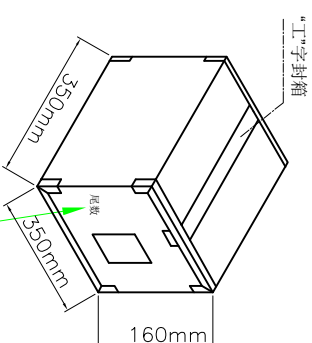
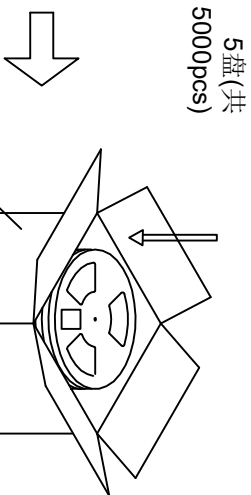

包装数量	净重	毛重
5000PCS/箱

PRODUCT CHAIR DWG		产品图	
公差一览表 TOLERANCE UNLESS OTHERWISE		深圳市鑫风雷电子有限公司 Shenzhen xinfenglei Electronic Co., Ltd	
X	±0.30	X	±0.5
XX	±0.25	X	±2
XXX	±0.15	XXX	±0.5
单位 UNITS	MM	比例 SCALE	1:1
日期 DATE	2009/10/20	制图 DRAWING	王冠 Wangguan
		审核 CHECK	雷永健 Leiyongjian
		核准 APPRO	雷永健 Leiyongjian
产品料号 PRODUCT PART NO.	8001M-1200004-B	产品名称 PRODUCT NO.	TYPE C 12P公头拉伸沉孔数0.95 L=1.3 75 外壳DIP
角法 VIEW		版本 VER	A0