

ROHS 客户图

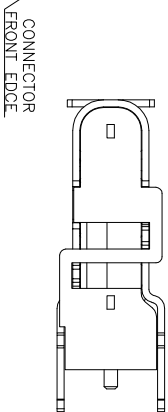
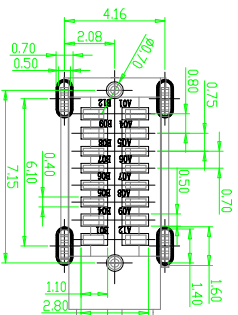
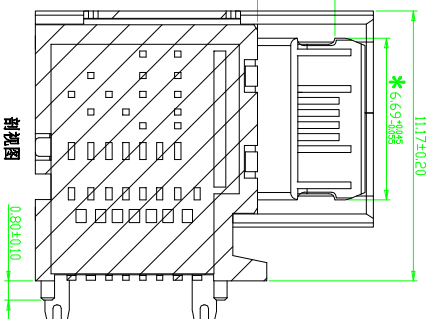
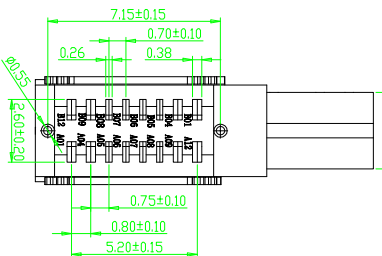
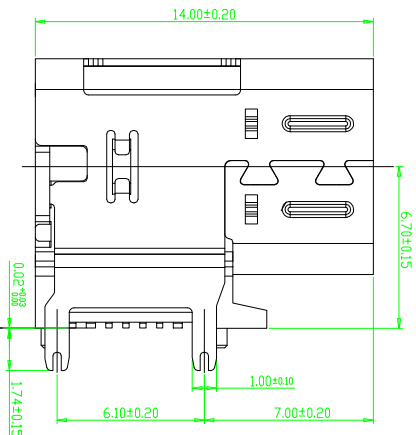
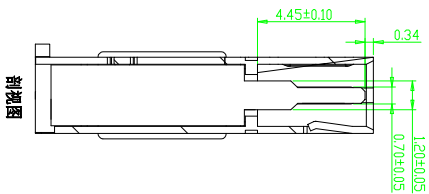
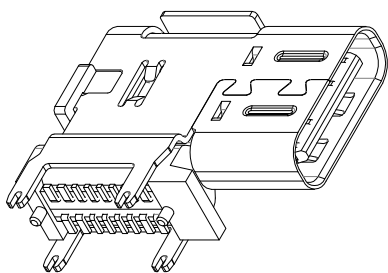
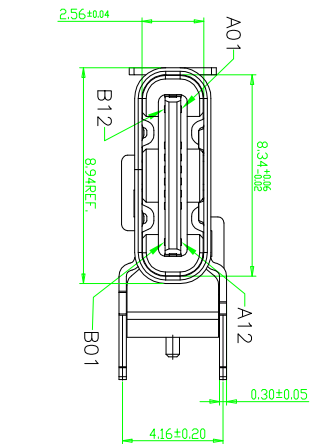

A1	GN0	B1E	GN0
A4	VBUS	B9	VBUS
A5	CC1	B8	SR02
A6	D1	B7	D1
A7	D1	B6	D1
A8	SR01	B5	CC2
A9	VBUS	B4	VBUS
A12	GN0	B1	GN0
PIN	SIGNAL NAME	PIN	SIGNAL NAME

- 特性:**
- 电气性能: ELECTRICAL
 - 额定电流: 5.0A
 - 接触阻抗: 40 MILLIOHMS MAX
 - 耐电压: 150V AC / 1 mA MAX
 - 绝缘阻抗: 150V DC/100 MEGA OHMS MIN
 - 机械性能:
 - 插入力: 5~20N
 - 拔出力: 8~20N
 - 使用寿命: 10000次、拔出力 6N MIN
 - 材料: MATERIAL
 - 塑胶: LCP/PA9T UL94V-0
 - 端子: C7025/C18400 T=0.20MM
 - 外壳: SUS304 T=0.30MM
 - 卡勾: SUS304 T=0.30MM
 - 电镀: FINISH
 - 端子: 接触点镀金30~MIN
PIN脚焊接区域镀金10~MIN.
 - 外壳: 镀镍500~MIN (盐雾48H)
 - 电镀品需做粘锡测试: 粘锡面积达到95%以上。
 - SMT回流焊 (峰值260° C±5° C) 不能起泡、熔胶、变色不良 (变形在公差范围以内)
 - 工作温度: -40° C +85° C

PART NO: 8001F-1600138 -A

SERISE: TYPE C |

Receptacle

serial number

Variable

产品图

PRODUCT CHART DWG

公差一览表

TOLERANCE UNLESS OTHERWISE	公差	UNIT
X	±0.30	MM
XX	±0.25	MM
XXX	±0.15	MM

深圳市鑫风雷电子有限公司
Shenzhen xinfenglei Electronics Co., Ltd

制图	王冠	产品料号	8001F-1600138-A
审核	雷永健	产品名称	TYPE C 16P母座侧插SMT CH=6, 7 L=14.0
核准	雷永健	联系方式	mailto:sale1@xfll.com www.xfll.com.com
日期	2009/10/20	DATE	

目錄	变更内容	日期
MAPX	MODIFICATION	DATE
A0	NEW	19-10-20

RoHS 客户图

目録 MAPX	设定内容 MODIFICATION	日期 DATE
A0	NEW	19-10-20

包装说明:

1. 将检验好的成品;插板脚朝下放入载带底部;每卷装400PCS产品;具体如图一所示
2. 将包装好的产品;每盘必需贴上内标签;具体如图二所示
3. 将贴好内标签的产品每8盘叠;具体如图三图四所示(3200PCS每箱)
5. 装好后并封好纸箱及贴好相关标签;具体如图五所示;
(产品包装的标签,如客户有要求,请按客户要求包装出货)
6. 载带前面留12PCS空格,后面留12PCS空格
7. COVER与CARRY剥离力:50-125g,速度:300mm/分钟左右,剥离角度:165°-180°

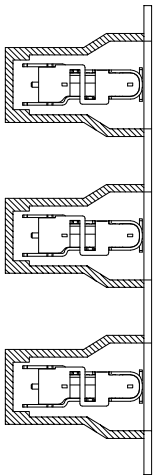
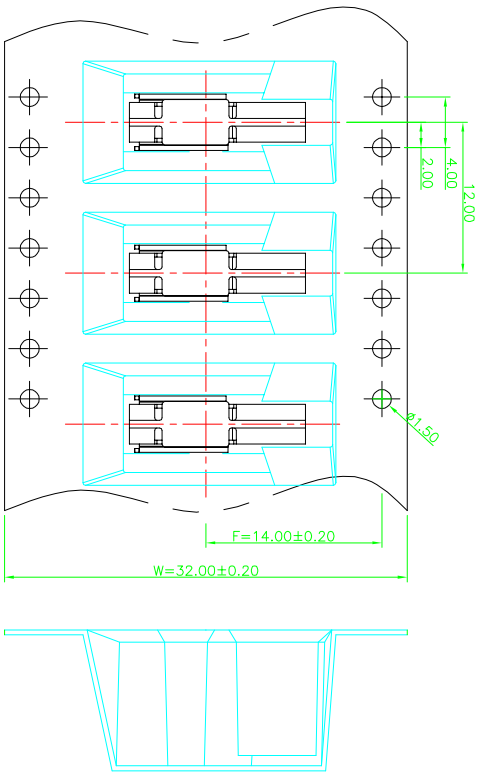

① 产品入载带示意图

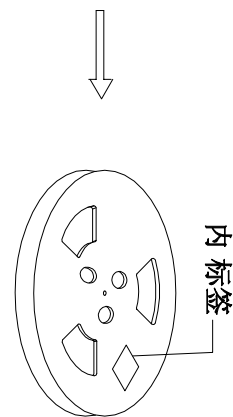

内标签

② 卷盘贴标签示意图

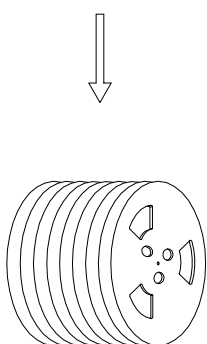

③ 8盘产品叠层示意图

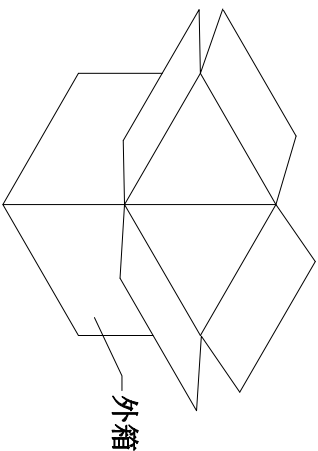

外箱

④ 产品入外箱示意图

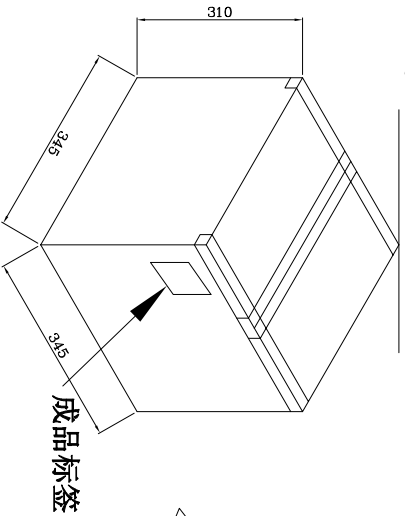

成品标签

⑤ 外箱封箱示意图

产品图 PRODUCT CHART DWG		公差一览表 TOLERANCE UNLESS OTHERWISE	
X	±0.30	X'	±5°
X	±0.25	X''	±2°
XX	±0.20	XX'	±1°
XXX	±0.15	XXX'	±0.5°

单位 UNITS	MM	制图 DRAWING	王冠 Wangguan	产品料号 PRODUCT PART NO.	8001F-1600138-X
比例 SCALE	1:1	审核 CHKD	雷永健 Lei Yongjian	产品名称 PRODUCT NO.	TYPE C 16P母座侧插SMT CH=6, 7 L=14.0
日期 DATE	2009/10/20	核准 APPRD	雷永健 Lei Yongjian	联系方式 Mailbox/ web	mailbox: sale1@xficom.com www. xficom. com

深圳市鑫风雷电子有限公司
Shenzhen xinfenglei Electronics Co., Ltd